

User Guide

Vaisala VaiNet Access Point

AP10

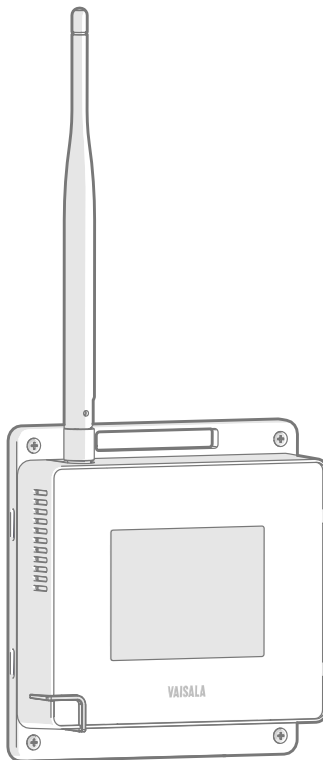

VAISALA

PUBLISHED BY

Vaisala Oyj
Vanha Nurmijärventie 21, FI-01670 Vantaa, Finland
P.O. Box 26, FI-00421 Helsinki, Finland
+358 9 8949 1

Visit our Internet pages at www.vaisala.com.

© Vaisala Oyj 2019

No part of this document may be reproduced, published or publicly displayed in any form or by any means, electronic or mechanical (including photocopying), nor may its contents be modified, translated, adapted, sold or disclosed to a third party without prior written permission of the copyright holder. Translated documents and translated portions of multilingual documents are based on the original English versions. In ambiguous cases, the English versions are applicable, not the translations.

The contents of this document are subject to change without prior notice.

Local rules and regulations may vary and they shall take precedence over the information contained in this document. Vaisala makes no representations on this document's compliance with the local rules and regulations applicable at any given time, and hereby disclaims any and all responsibilities related thereto.

This document does not create any legally binding obligations for Vaisala towards customers or end

users. All legally binding obligations and agreements are included exclusively in the applicable supply contract or the General Conditions of Sale and General Conditions of Service of Vaisala.

This product contains software developed by Vaisala or third parties. Use of the software is governed by license terms and conditions included in the applicable supply contract or, in the absence of separate license terms and conditions, by the General License Conditions of Vaisala Group.

This product may contain open source software (OSS) components. In the event this product contains OSS components, then such OSS is governed by the terms and conditions of the applicable OSS licenses, and you are bound by the terms and conditions of such licenses in connection with your use and distribution of the OSS in this product. Applicable OSS licenses are included in the product itself or provided to you on any other applicable media, depending on each individual product and the product items delivered to you.

Table of Contents

1.	About This Document	5
1.1	Version Information.....	5
1.2	Related Manuals.....	5
1.3	Documentation Conventions.....	5
1.4	Trademarks.....	6
2.	Product Overview	7
2.1	Overview of AP10 Access Point.....	7
2.2	AP10 Parts.....	8
2.3	VaiNet Devices in viewLinc Monitoring System.....	9
2.3.1	VaiNet Protocol.....	9
2.3.2	Data Transfer in a VaiNet Network.....	10
2.4	Time Synchronization.....	11
2.5	Network Security.....	11
2.6	Power Supply.....	11
2.7	Remote Management.....	12
2.8	Regulatory Compliance.....	13
2.8.1	FCC Compliance Statement.....	13
2.8.2	ISED Compliance Statement.....	14
2.8.3	EU Declaration of Conformity.....	14
2.8.4	UAE Compliance.....	16
2.9	Symbols Used in AP10 Product Markings.....	16
2.10	ESD Protection.....	17
3.	Installation	18
3.1	AP10 Installation Location and Range.....	18
3.1.1	Mounting in Plenum Space.....	18
3.2	Setting Up AP10.....	19
3.3	Mounting AP10.....	20
4.	Touchscreen Interface	23
4.1	Accessing the Touchscreen Interface.....	23
4.2	Overview of Touchscreen Interface.....	23
5.	Web Interface	26
5.1	Accessing the Web Interface.....	26
5.2	Overview of Web Interface.....	27
6.	Maintenance	35
6.1	Cleaning AP10.....	35
6.2	Updating AP10 Firmware.....	35
7.	Troubleshooting	38
7.1	Problem Situations.....	38
7.2	Verifying Operation of AP10.....	39
7.3	Performing a Factory Reset.....	40

- 8. Technical Data.....41**
- 8.1 AP10 Technical Specification..... 41
- 8.2 AP10 Spare Parts and Accessories.....43
- 8.3 AP10 Dimensions.....44

- Technical Support..... 45**

- Warranty.....45**

- Recycling.....45**

List of Figures

Figure 1	AP10 in the viewLinc Monitoring System.....	7
Figure 2	Front.....	8
Figure 3	Connector Panel.....	8
Figure 4	Rear.....	9
Figure 5	AP10 Remote Management Using viewLinc Enterprise Server.....	12
Figure 6	AP10 Properties in viewLinc.....	13
Figure 7	AP10 Mounting Methods.....	21
Figure 8	AP10 Screw Mounting Dimensions.....	22
Figure 9	Touch Interface Home Screen.....	23
Figure 10	Touch Interface Data Logger Information Screen.....	24
Figure 11	Touch Interface Settings Menu.....	25
Figure 12	Web Interface System Summary Page.....	27
Figure 13	Web Interface Data Loggers Page.....	28
Figure 14	Web Interface Network Settings.....	29
Figure 15	Web Interface DNS, NTP, and VaiNet Settings Page.....	29
Figure 16	Web Interface viewLinc Settings Page.....	30
Figure 17	Web Interface Installation Mode Settings Page.....	30
Figure 18	Web Interface Security Settings Page.....	31
Figure 19	Web Interface Display and LED Settings Page.....	31
Figure 20	Web Interface Backup and Restore Page.....	32
Figure 21	Web Interface Firmware Update Page.....	33
Figure 22	Web Interface Restart and Reset Page.....	33
Figure 23	Web Interface Support Page.....	34
Figure 24	Firmware Update Page in Web Interface.....	36
Figure 25	AP10 Access Point Dimensions.....	44

List of Tables

Table 1	Document Versions (English).....	5
Table 2	Related Manuals.....	5
Table 3	AP10 Power Supply Specifications.....	11
Table 4	Symbols Used in AP10 Product Markings.....	16
Table 5	Troubleshooting Table.....	38
Table 6	Wireless.....	41
Table 7	Operating Environment.....	41
Table 8	Inputs and Outputs.....	42
Table 9	Mechanical Specifications.....	42
Table 10	Spare Parts and Accessories.....	43

1. About This Document

1.1 Version Information

Table 1 Document Versions (English)

Document Code	Date	Description
M211860EN-C	February 2019	This document. Updated regulatory compliance information and sections Overview of Web Interface (page 27) and Updating AP10 Firmware (page 35) .
M211860EN-B	July 2018	Previous version. Updated descriptions of touchscreen interface and web interface.
M211860EN-A	May 2018	First version.

1.2 Related Manuals

Table 2 Related Manuals

Document Code	Name
M211821EN	<i>AP10 Access Point Quick Guide</i>
M211820EN	<i>viewLinc Monitoring System Setup Guide</i>
M211975EN	<i>viewLinc Enterprise Server User Guide</i>
M211822EN	<i>RFL100 Data Logger Quick Guide</i>
M211861EN	<i>RFL100 Data Logger User Guide</i>

1.3 Documentation Conventions



WARNING! Warning alerts you to a serious hazard. If you do not read and follow instructions carefully at this point, there is a risk of injury or even death.



CAUTION! Caution warns you of a potential hazard. If you do not read and follow instructions carefully at this point, the product could be damaged or important data could be lost.



Note highlights important information on using the product.



Tip gives information for using the product more efficiently.



Lists tools needed to perform the task.



Indicates that you need to take some notes during the task.

1.4 Trademarks

Vaisala® is a registered trademark of Vaisala Oyj.

The LoRa™ name and associated logo are trademarks of Semtech Corporation or its subsidiaries.

All other product or company names that may be mentioned in this publication are trade names, trademarks, or registered trademarks of their respective owners.

2. Product Overview

2.1 Overview of AP10 Access Point

Vaisala VaiNet Access Point AP10 is a wireless access point that collects data from VaiNet wireless data loggers and transfers it to viewLinc Enterprise Server using a wired Ethernet connection. AP10 implements Vaisala's proprietary VaiNet protocol. It can connect up to 32 RFL100 Data Loggers to Vaisala viewLinc Monitoring System. The wireless connection operates on 868 MHz or 915 MHz frequency band depending on the model. For more information on viewLinc system installation, see *viewLinc Setup Guide (M211820EN)*.

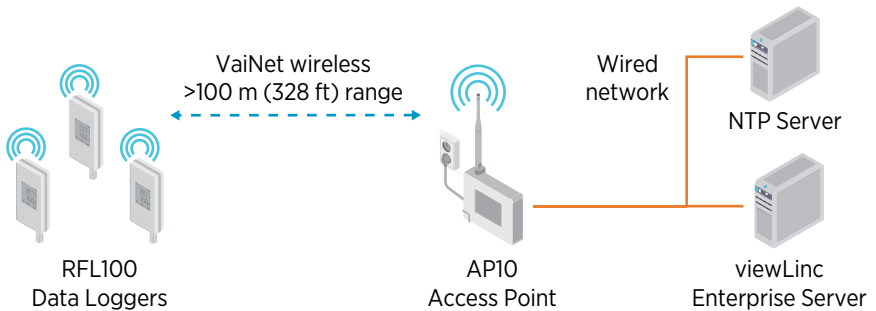

Figure 1 AP10 in the viewLinc Monitoring System

AP10 can be powered from the Ethernet connector using Power over Ethernet (PoE) or from the power supply connector using the included AC/DC adapter. If both power sources are connected, the AC/DC adapter is utilized to power the device. AP10 is IP22 rated, and is suitable for indoor industrial applications.

AP10 has two user interfaces:

- Touch interface on the front panel. Use this interface to set up the device during installation and to locally check the connection status.
- Web interface via the Ethernet connection. This interface provides advanced configuration features and can be accessed remotely.

More Information

- [Overview of Touchscreen Interface \(page 23\)](#)
- [Overview of Web Interface \(page 27\)](#)
- [AP10 Technical Specification \(page 41\)](#)

2.2 AP10 Parts

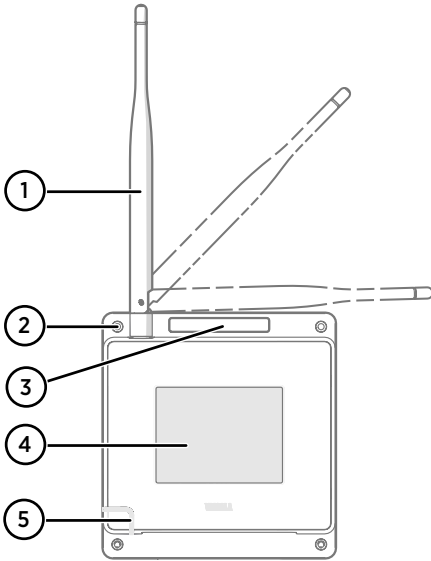

Figure 2 Front

- 1 Antenna. Can be rotated and tilted.
- 2 Screw holes for mounting (4 pcs), \varnothing 3.2 mm
- 3 Ventilation hole (do not cover)
- 4 Touchscreen
- 5 Status LED:

Green Normal operation
Blue Installation mode active
Red Error - check status

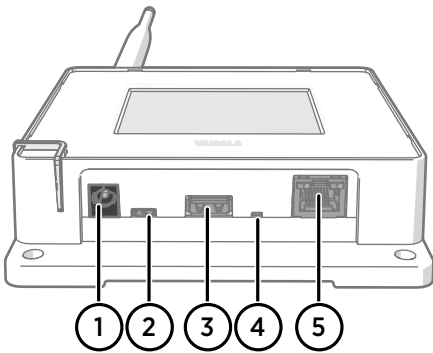

Figure 3 Connector Panel

- 1 Power supply connector (10 ... 30 VDC)
- 2 Service port (micro-USB)
- 3 USB port for hardware expansion (USB type A)
- 4 Reset button. Push to restart, push and hold to revert AP10 to factory settings.
- 5 RJ-45 Ethernet port. Can be powered by Power over Ethernet (PoE).

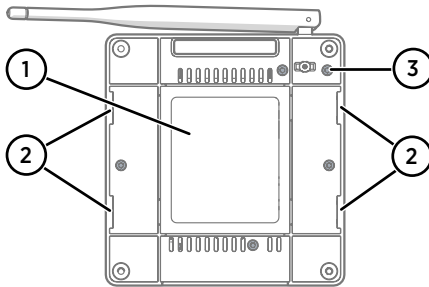

Figure 4 Rear

- 1 Product label
- 2 Holes for mounting with tie wraps
- 3 Housing screws (do not remove)

2.3 VaiNet Devices in viewLinc Monitoring System

VaiNet access points create links between Ethernet and Vaisala devices using the VaiNet protocol. Wireless device registration is handled by viewLinc Enterprise Server. Whenever a new data logger is added to the system, it is automatically identified by an access point, which forwards the data logger's information to the server. Once accepted in the system, data loggers will stay synchronized, even in situations where other nearby VaiNet networks overlap. Redundancy is achieved by allowing load distribution between VaiNet access points which share multiple data loggers in range.

VaiNet access points transfer measurement data from the data loggers to viewLinc Enterprise Server. Both access point and viewLinc Enterprise Server verify that the data has been received correctly. Once the data has been verified, it is stored to the secure database where it is protected from tampering and loss.

If data flow is interrupted by a network outage, the data transfer will resume when the outage is resolved. Local memory of the data logger is used to store the data while waiting for a connection to viewLinc Enterprise Server. RFL100 Data Logger has enough local memory for 30 days of measurement.

2.3.1 VaiNet Protocol

Vaisala's VaiNet wireless protocol is based on LoRa™ technology. This technology has been licensed by Vaisala for monitoring purposes, and further enhanced additional protocol layers to produce a robust and reliable wireless signal for environmental monitoring. The protocol is proprietary, and cannot be used with 802.11 Wi-Fi devices. VaiNet wireless devices always require a VaiNet wireless access point.

VaiNet radio communication uses a modulated, low-power signal at sub-GHz frequencies to provide better signal propagation in environmental monitoring applications. VaiNet provides all the benefits of spread spectrum wireless technology including resistance to interference, interception and multipath fading (reflections). Using the chirp signal to spread the RF energy over a wider band allows for reliable communications even when signal levels are below the background noise floor. It also reduces disruptions from overlapping signals on same frequencies.

VaiNet wireless devices are not limited to using a single access point. If multiple access points are available, VaiNet devices can switch access points to maintain their connection to the viewLinc Monitoring System. The strength of the wireless signal is used to determine the optimum network data path.

Wireless transmissions between VaiNet devices are encrypted to protect against eavesdropping, data tampering, and transfer errors.

2.3.2 Data Transfer in a VaiNet Network

VaiNet protocol and VaiNet devices are designed for power-efficient operation. To save energy VaiNet network transfers data at set intervals, which may be apparent to the user as longer data transfer times before the data is available on viewLinc Monitoring System.

Intermittent Radio Connections

Access points take turns communicating in a two-minute cycle, and connected data loggers send their measurement data to their connected access point every four minutes. This introduces the following scenarios:

- Data loggers that are not currently connected (new devices or ones that have fallen out of radio contact) scan for available access points for a complete cycle before they can decide what is the optimal access point for them. Connection attempts typically take at least a couple of minutes. Additionally, some joining scenarios may take multiple attempts. For example, when filling a single access point up to its full capacity of 32 data loggers, it may take an hour for the last data logger to successfully connect to the access point.
- Access points request missing data and issue management commands to data loggers within their communication window. Transferring a full month's worth of measurement data from 32 data loggers using one access point takes several hours.

Data Logger Scanning Interval

Scanning for available access points consumes power. To prevent repeated scanning from draining their batteries, RFL100 Data Loggers shut down their radio temporarily if they can find no access points to join. They will resume scanning after a waiting interval that gets progressively longer if they keep failing to find an access point. The maximum interval is 8 hours and 30 minutes.

This means that when access points become available after an outage, it may take several hours for data loggers to discover them. This is why you should always keep your access points powered up, and why you should start your network installation by installing the viewLinc Enterprise Server and access points first.



You can manually wake up the radio of an RFL100 Data Logger by pressing its **Refresh** button. The button is located next to the service port under the silicone plug.

2.4 Time Synchronization

AP10 requires accurate time to operate its VaiNet wireless connection, and to maintain correct time on the connected data loggers. To achieve the accurate time, AP10 synchronizes with Network Time Protocol (NTP) servers. The hostnames of the default NTP servers are:

0.pool.ntp.org

1.pool.ntp.org

2.pool.ntp.org

3.pool.ntp.org

Reaching the default NTP servers requires an internet connection. To allow the AP10 to operate without an internet connection, replace one of the default NTP server addresses with the address of your local NTP server.

AP10 has a supercapacitor as a backup power source for its realtime clock. If AP10 is left without power for more than a day, the realtime clock will lose its time. If this happens AP10 will have to synchronize its clock with the NTP servers before it can operate its radio. This is typically the case when an AP10 is installed - it needs to synchronize its clock before it can start to connect VaiNet data loggers. Synchronization is also needed due to clock drift if the NTP servers cannot be reached for more than three weeks.



Synchronizing with the NTP servers typically takes several minutes, during which time the access point will show the NTP connection error. If you have just turned on your access point or changed its NTP server configuration, it is normal to see the error for up to 15 minutes.

2.5 Network Security

AP10 Access Point is intended to be connected to a secure internal network, not directly to the internet.

2.6 Power Supply

A DC power supply (Vaisala item 244784SP) is included with every AP10 Access Point.

Table 3 AP10 Power Supply Specifications

Property	Specification
Operating voltage	10 ... 30 VDC
Output power	min. 13 W
Output current	min. 1.3 A

Property	Specification
Output connector	Locking type female coaxial connector with positive 2.0 mm center pin
Operating temperature range	-20 ... +60 °C (-4 ... +140 °F)
Operating humidity range	0 ... 95 %RH, non-condensing
Certifications and approvals	<ul style="list-style-type: none"> • Certified to IEC 60950-1 or IEC 62368-1 • Approved for use in your country

2.7 Remote Management

API0 has a web interface for remote management. Additionally, some settings can be remotely managed using viewLinc Enterprise Server software. Remote management operations can be performed directly from the **Sites Manager > Hosts and Devices** tree.

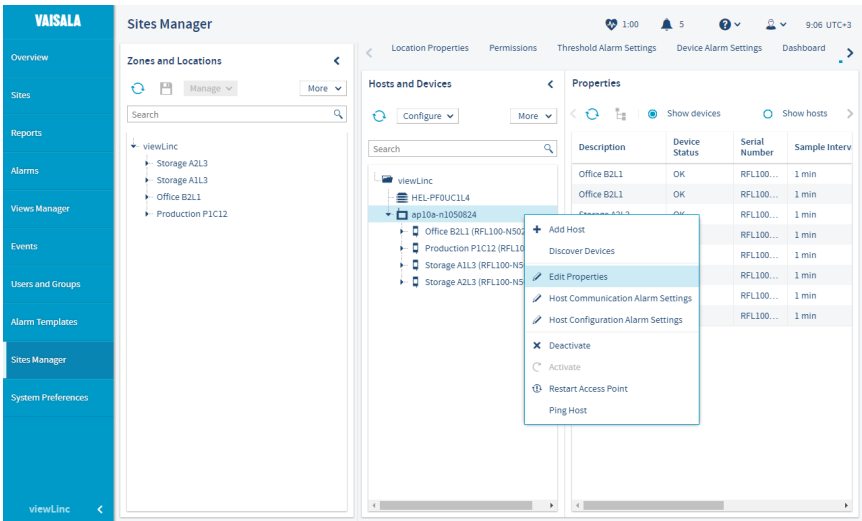

Figure 5 API0 Remote Management Using viewLinc Enterprise Server

Edit Host Properties

Property	Value
Host name	ap10a-n1050824
Description	
Installation mode	Disabled
VaiNet channel (1-8)	6
AP display	On
AP display brightness	100%
AP LED	On
AP LED brightness	100%

Figure 6 AP10 Properties in viewLinc



Select **Sites Manager > Show hosts** to see the IP addresses of all connected hosts. Select the IP address of any AP10 to open its web interface in your browser.

2.8 Regulatory Compliance

2.8.1 FCC Compliance Statement

This equipment has been tested and found to comply with the limits for a Class A digital device, pursuant to part 15 of the FCC Rules. These limits are designed to provide reasonable protection against harmful interference when the equipment is operated in a commercial environment. This equipment generates, uses, and can radiate radio frequency energy and, if not installed and used in accordance with the instruction manual, may cause harmful interference to radio communications. Operation of this equipment in a residential area is likely to cause harmful interference in which case the user will be required to correct the interference at his own expense.



WARNING! Changes or modifications to this equipment not expressly approved by the party responsible for compliance could void the user's authority to operate the equipment.



WARNING! This device complies with part 15 of the FCC Rules. Operation is subject to the following two conditions: (1) This device may not cause harmful interference, and (2) this device must accept any interference received, including interference that may cause undesired operation.

2.8.2 ISED Compliance Statement

This device complies with Industry Canada licence-exempt RSS standard(s). Operation is subject to the following two conditions:

1. This device may not cause interference; and
2. This device must accept any interference, including interference that may cause undesired operation of the device.

This device has a whip antenna with a gain of 3 dBi.

Le présent appareil est conforme aux CNR d'Industrie Canada applicables aux appareils radio exempts de licence. L'exploitation est autorisée aux deux conditions suivantes:

1. l'appareil ne doit pas produire de brouillage, et
2. l'utilisateur de l'appareil doit accepter tout brouillage radioélectrique subi, même si le brouillage est susceptible d'en compromettre le fonctionnement.

Le présent appareil dispose d'une antenne fouet avec un gain de 3 dBi.



CAUTION! This device requires a separation distance of at least 20 cm. This distance must be maintained between the user and the device when the device is operating.



CAUTION! Cet appareil nécessite une distance de séparation d'au moins 20 cm. Cette distance doit être maintenue entre l'utilisateur et l'appareil lorsque l'appareil est en fonctionnement.

2.8.3 EU Declaration of Conformity

BG: С настоящото Vaisala Oyj декларира, че този тип радиосъоръжение AP10 е в съответствие с Директива 2014/53/ЕС. Цялостният текст на ЕС декларацията за съответствие може да се намери на следния интернет адрес: www.vaisala.com/declarationofconformity

CS: Tímto Vaisala Oyj prohlašuje, že typ rádiového zařízení AP10 je v souladu se směrnicí 2014/53/EU. Úplné znění EU prohlášení o shodě je k dispozici na této internetové adrese: www.vaisala.com/declarationofconformity

DA: Hermed erklærer Vaisala Oyj, at radioudstyrstypen AP10 er i overensstemmelse med direktiv 2014/53/EU. EU-overensstemmelseserklæringens fulde tekst kan findes på følgende internetadresse: www.vaisala.com/declarationofconformity

DE: Hiermit erklärt Vaisala Oyj , dass der Funkanlagentyp AP10 der Richtlinie 2014/53/EU entspricht. Der vollständige Text der EU-Konformitätserklärung ist unter der folgenden Internetadresse verfügbar: www.vaisala.com/declarationofconformity

EL: Με την παρούσα ο/η Vaisala Oyj , δηλώνει ότι ο ραδιοεξοπλισμός AP10 πληροί την οδηγία 2014/53/ΕΕ. Το πλήρες κείμενο της δήλωσης συμμόρφωσης ΕΕ διατίθεται στην ακόλουθη ιστοσελίδα στο διαδίκτυο: www.vaisala.com/declarationofconformity

EN: Hereby, Vaisala Oyj declares that the radio equipment type AP10 is in compliance with Directive 2014/53/EU. The full text of the EU declaration of conformity is available at the following internet address: www.vaisala.com/declarationofconformity

ES: Por la presente, Vaisala Oyj declara que el tipo de equipo radioeléctrico AP10 es conforme con la Directiva 2014/53/UE. El texto completo de la declaración UE de conformidad está disponible en la dirección Internet siguiente: www.vaisala.com/declarationofconformity

ET: Käesolevaga deklareerib Vaisala Oyj , et käesolev raadioseadme tüüp AP10 vastab direktiivi 2014/53/EL nõuetele. ELi vastavusdeklaratsiooni täielik tekst on kättesaadav järgmisel internetiaadressil: www.vaisala.com/declarationofconformity

FI: Vaisala Oyj vakuuttaa, että radiolaitetyypin AP10 on direktiivin 2014/53/EU mukainen. EU-vaatimustenmukaisuusvakuutuksen täysimittainen teksti on saatavilla seuraavassa internetosoitteessa: www.vaisala.com/declarationofconformity

FR: Le soussigné, Vaisala Oyj , déclare que l'équipement radioélectrique du type AP10 est conforme à la directive 2014/53/UE. Le texte complet de la déclaration UE de conformité est disponible à l'adresse internet suivante: www.vaisala.com/declarationofconformity

HR: Vaisala Oyj ovime izjavljuje da je radijska oprema tipa AP10 u skladu s Direktivom 2014/53/EU. Cjeloviti tekst EU izjave o sukladnosti dostupan je na sljedećoj internetskoj adresi: www.vaisala.com/declarationofconformity

HU: Vaisala Oyj igazolja, hogy a AP10 típusú rádióberendezés megfelel a 2014/53/EU irányelvnek. Az EU-megfelelőségi nyilatkozat teljes szövege elérhető a következő internetes címen: www.vaisala.com/declarationofconformity

IT: Il fabbricante, Vaisala Oyj , dichiara che il tipo di apparecchiatura radio AP10 è conforme alla direttiva 2014/53/UE. Il testo completo della dichiarazione di conformità UE è disponibile al seguente indirizzo Internet: www.vaisala.com/declarationofconformity

LT: Aš, Vaisala Oyj , patvirtinu, kad radijo įrenginių tipas AP10 atitinka Direktyvą 2014/53/ES. Visas ES atitikties deklaracijos tekstas prieinamas šiuo interneto adresu: www.vaisala.com/declarationofconformity

LV: Ar šo Vaisala Oyj deklarē, ka radioiekārta AP10 atbilst Direktīvai 2014/53/ES. Pilns ES atbilstības deklarācijas teksts ir pieejams šādā interneta vietnē: www.vaisala.com/declarationofconformity

MT: B'dan, Vaisala Oyj , niddikjara li dan it-tip ta' taghmir tar-radju AP10 huwa konformi mad-Direttiva 2014/53/UE. It-test kollu tad-dikjarazzjoni ta' konformità tal-UE huwa disponibbli f'dan l-indirizz tal-Internet li ġej: www.vaisala.com/declarationofconformity

NL: Hierbij verklaar ik, Vaisala Oyj , dat het type radioapparatuur AP10 conform is met Richtlijn 2014/53/EU. De volledige tekst van de EU-conformiteitsverklaring kan worden geraadpleegd op het volgende internetadres: www.vaisala.com/declarationofconformity

PL: Vaisala Oyj niniejszym oświadcza, że typ urządzenia radiowego API0 jest zgodny z dyrektywą 2014/53/UE. Pełny tekst deklaracji zgodności UE jest dostępny pod następującym adresem internetowym: www.vaisala.com/declarationofconformity

PT: O(a) abaixo assinado(a) Vaisala Oyj declara que o presente tipo de equipamento de rádio API0 está em conformidade com a Diretiva 2014/53/UE. O texto integral da declaração de conformidade está disponível no seguinte endereço de Internet: www.vaisala.com/declarationofconformity

RO: Prin prezenta, Vaisala Oyj declară că tipul de echipamente radio API0 este în conformitate cu Directiva 2014/53/UE. Textul integral al declarației UE de conformitate este disponibil la următoarea adresă internet: www.vaisala.com/declarationofconformity

SK: Vaisala Oyj týmto vyhlasuje, že rádiové zariadenie typu API0 je v súlade so smernicou 2014/53/EÚ. Úplné EÚ vyhlásenie o zhode je k dispozícii na tejto internetovej adrese: www.vaisala.com/declarationofconformity

SL: Vaisala Oyj potrjuje, da je tip radijske opreme API0 skladen z Direktivo 2014/53/EU. Celotno besedilo izjave EU o skladnosti je na voljo na naslednjem spletnem naslovu: www.vaisala.com/declarationofconformity



SV: Härmed försäkrar Vaisala Oyj att denna typ av radioutrustning API0 överensstämmer med direktiv 2014/53/EU. Den fullständiga texten till EU-försäkran om överensstämmelse finns på följande webbadress: www.vaisala.com/declarationofconformity







2.8.4 UAE Compliance

TRA
Registered No: ER67585/18
Dealer No: DA78828/18

2.9 Symbols Used in API0 Product Markings

Table 4 Symbols Used in API0 Product Markings

Symbol	Description
	Meets the essential requirements of the applicable EC directives
	Symbol of electrical and electronic equipment according to the WEEE directive
	FCC mark

Symbol	Description
	Environment Friendly Use Period of 10 years
	DC power
	Center polarity positive
	Read user instructions
	Trade mark of the manufacturer
	Level VI efficiency rating
	Class II equipment

2.10 ESD Protection

Electrostatic Discharge (ESD) can cause immediate or latent damage to electronic circuits. Vaisala products are adequately protected against ESD for their intended use. However, it is possible to damage the product by delivering an electrostatic discharge when touching, removing or inserting any objects inside the equipment housing.

Avoid touching component contacts or connectors when working with the device.

3. Installation

3.1 AP10 Installation Location and Range

In a typical indoor space, the wireless range of AP10 is at least 100 m (328 ft). In an open space with line-of-sight and no interfering structures, the range can be over 500 m (1640 ft). Up to 8 access points can be placed within range of each other, even side-by-side, as long as they each have their own VaiNet channel.

Walls and ceilings are good locations for AP10. Line of sight is not required. If possible, place AP10 in the same floor as the data loggers. Point the antenna up or down for best wireless performance.

Avoid placing AP10 close to large metal surfaces, as they may reduce the range of the radio signal.

3.1.1 Mounting in Plenum Space

Plenum space is a separate air circulation space that is used by the building's heating and air conditioning systems. For example, the space between the structural floor and the dropped ceiling is typically used as an air-handling space. Due to fire safety considerations, the materials placed in plenum space may be restricted by local legislation.

If you need to mount the access point in a plenum space but its materials do not meet your local requirements, you can mount the access point inside a commercially available enclosure that is meant for this purpose. For example, model 1075CP ceiling enclosure from Oberon Wireless is suitable.

When selecting a plenum mounting enclosure, note the following requirements:

- The inside dimensions of the enclosure must be large enough for the access point. There should be enough space to rotate the antenna if desired, and to easily connect the cabling.
- The enclosure must not completely block the radio transmissions of the access point.

3.2 Setting Up AP10

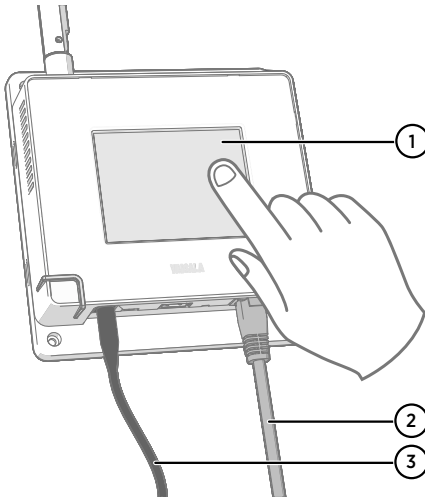



- 1 Touchscreen.
- 2 Ethernet cable. You must use a shielded cable to meet the rated EMC performance of the device.
- 3 Cable from DC power supply.

- ▶ 1. Connect the Ethernet cable to Ethernet port of AP10. If possible, connect to the same network where the viewLinc Enterprise Server is, so that you can verify the connection when doing the setup.
2. If the Ethernet cable does not provide power, connect the DC power supply:
 - a. Remove the DC power supply from the AP10 package.
 - b. The power supply comes with multiple adapters for wall sockets. Connect the adapter you need to the power supply before attempting to use it.
 - c. Plug in the power supply to the wall socket.
 - d. Connect the plug to the power supply connector of AP10. Make sure the plug is oriented correctly and goes in all the way.
 - e. Rotate the power plug slightly to lock it to the connector.

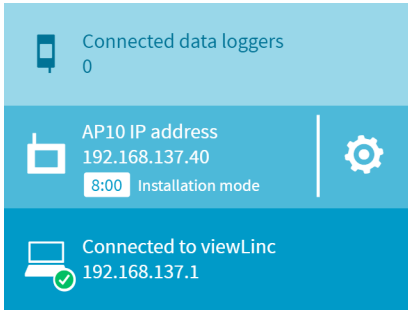
3. A setup wizard starts when API0 is first powered up. Use the touch interface to complete the wizard:
 - a. Select a language for the touchscreen display.
 - b. Configure the network settings so that API0 can join the network.
 - c. Configure the Network Time Protocol (NTP) servers that the access point will attempt to synchronize with. If you have a local NTP server in the network, replace one of the default NTP server hostnames with its IP address or hostname.
 - d. Select a **VaiNet channel** (1 ... 8). Each access point in range of each other must have a unique channel assigned to it.
 - e. Enter the IP address or hostname of the viewLinc Enterprise Server. Leave the **TCP port** at default 12600 unless you know it has been changed.
 - f. Enable **Installation Mode** to start connecting data loggers to your system.
4. After the setup wizard is complete, wait for the display to change to the home screen where you can see the status of the access point at a glance.



 An NTP connection error continues to be shown while API0 is synchronizing time with the listed NTP servers. It may take up to 15 minutes for it to disappear even when the NTP servers are reachable. Wait patiently.

 To change the configuration of the access point, touch the  symbol to open the **Settings** screen.

3.3 Mounting API0

- 
 - API0 Access Point, set up and configured
 - Content of API0 delivery package
 - Crosshead screwdriver (if screw mounting is used)

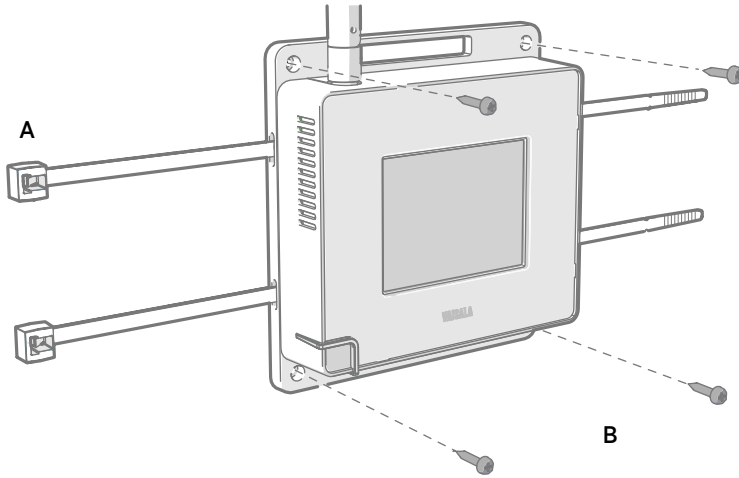

Figure 7 AP10 Mounting Methods

- A Mounting with cable ties (2 pcs)
- B Mounting with screws (4 pcs)

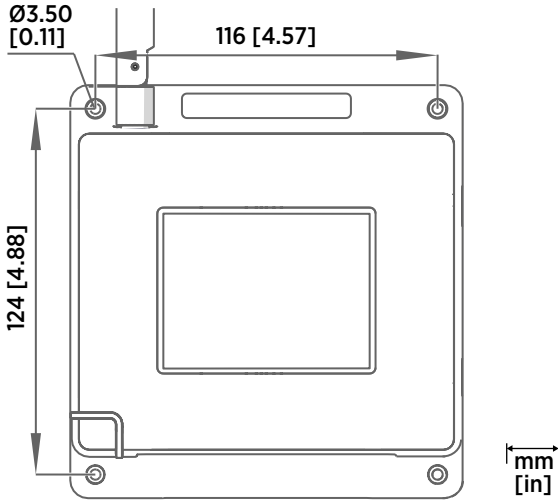

Figure 8 API0 Screw Mounting Dimensions

- ▶ 1. Attach API0 to its mounting location using the most suitable mounting option. Ensure the unit is securely fixed if you are mounting it higher than 2 m (approx. 6 ft) or in a location where it would pose a hazard if dropped.
- 2. Point the antenna up or down for best wireless performance.
- 3. Connect the Ethernet cable.
- 4. If the Ethernet cable does not provide power, connect the DC power supply:
 - a. Connect the plug to the power supply connector of API0. Make sure the plug is oriented correctly and goes in all the way.
 - b. Rotate the power plug slightly to lock it to the connector.
 - c. Connect the power supply to the wall socket.
- 5. Secure the power supply so it does not fall or hang on its cable.
- 6. Wait for the access point to start up. Verify from the touchscreen that the access point has an IP address, and it is connected to viewLinc.
 You may also see an error message about the NTP server connection. It should disappear within 15 minutes as the access point synchronizes its internal clock with the NTP server.

4. Touchscreen Interface

4.1 Accessing the Touchscreen Interface

The display on AP10 is a capacitive touchscreen. The touchscreen interface may be locked by a password.

- ▶ 1. Touch the screen to start using the interface. Do not wear gloves when using the touchscreen.
2. If the password query has been enabled, you will be prompted to enter the password using the on-screen keypad. The default password is **ap123456**.

4.2 Overview of Touchscreen Interface

Touchscreen interface is the most convenient way to set up the access point, and available for use whenever physical access is available. For remote management, use the web interface or viewLinc Enterprise Server.



Touchscreen interface does not provide measurement results or graphs, and it does not communicate any threshold alarms.

Home Screen

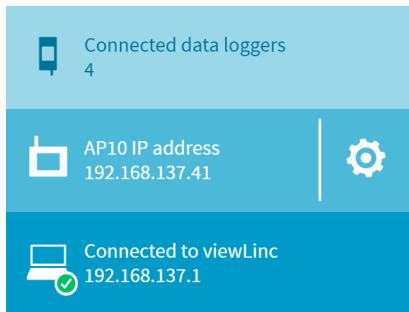



Figure 9 Touch Interface Home Screen

Home screen provides an overview of the connection status of the access point. The screen is split into three parts:

- Top: number of currently connected data loggers. Touch to browse through their information.

- Middle: access point IP address and status. Touch the  symbol to open the **Settings** screen.
- Bottom: status of viewLinc Enterprise Server connection.

Connected Data Loggers



Figure 10 Touch Interface Data Logger Information Screen

Data logger information screen shows connection and battery level status of each data logger that is connected to this access point. **Last connection** is the amount of time since last successful contact with the data logger.

After a data logger has been out of contact for more than 32 minutes, it will be removed from the list of connected data loggers. Since the access point only removes one data logger from the list during one scan cycle, data loggers that are out of contact may remain on the list even longer. It is possible for data loggers to be listed on more than one access point simultaneously when they are changing access points.

Settings

Settings screen provides local access to most of the access point's settings. Some advanced functionality, such as firmware update, are only available using the web interface.

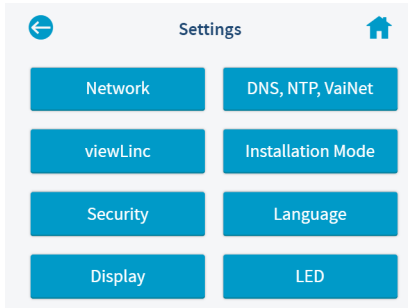

Figure 11 Touch Interface Settings Menu

5. Web Interface

5.1 Accessing the Web Interface



- Computer with a supported web browser (Google Chrome™, Microsoft® Internet Explorer® 11, or Microsoft Edge™)

Touchscreen interface may be hard to access after AP10 has been installed. AP10 also has a web interface that you can use to remotely view access point status and configure its settings.

- ▶ 1. Verify the IP address of the access point from the touchscreen interface.
2. Open a web browser.
3. In the address field of the web browser, enter **https://** and the IP address of AP10. For example: **https://192.168.10.47**
4. The default user interface language is English. If you want to use another language for this session, select it from the drop-down menu.
5. Enter the login information:
 - **User name:** `apadmin`
 - **Password:** `ap123456` (default)
6. Select **Log in** to access the interface.

5.2 Overview of Web Interface

System Summary

System Summary page lists the identifying information and current operating settings of the access point. Some information, such as the hardware ID of the device, are only available on this page.

The screenshot shows the Vaisala web interface for an AP10. The left sidebar contains navigation links: System Summary (selected), Data Loggers, Network Settings, DNS, NTP, and Vainet, view.Linc Settings, Installation Mode, Security Settings, Display and LED, and AP10 Maintenance. The main content area is titled 'System Summary' and shows the following information:

General	
Name	AP10E
Description	
Serial number	AP10E-N1050824
Host name	AP10A-N1050824.mshome.net
MAC address	68:9e:19:5b:5b:96
Frequency	868 MHz
Firmware version	release v.2.0.0 -
Hardware ID	F
Connected data loggers	4
Network Settings	
AP10 IP address	192.168.137.182
Subnet mask	255.255.255.0
Default gateway	192.168.137.1
DNS, NTP, and Vainet	
DNS 1	192.168.137.1
DNS 2	
NTP 1	0.pool.ntp.org
NTP 2	1.pool.ntp.org
NTP 3	2.pool.ntp.org
NTP 4	3.pool.ntp.org

Figure 12 Web Interface System Summary Page

Data Loggers

Data Loggers page lists each data logger that is connected to this access point. You can see the latest measurement values, battery level, and the signal quality of the VaiNet connection to the data logger. **Last connection** is the amount of time since last successful contact with the data logger.

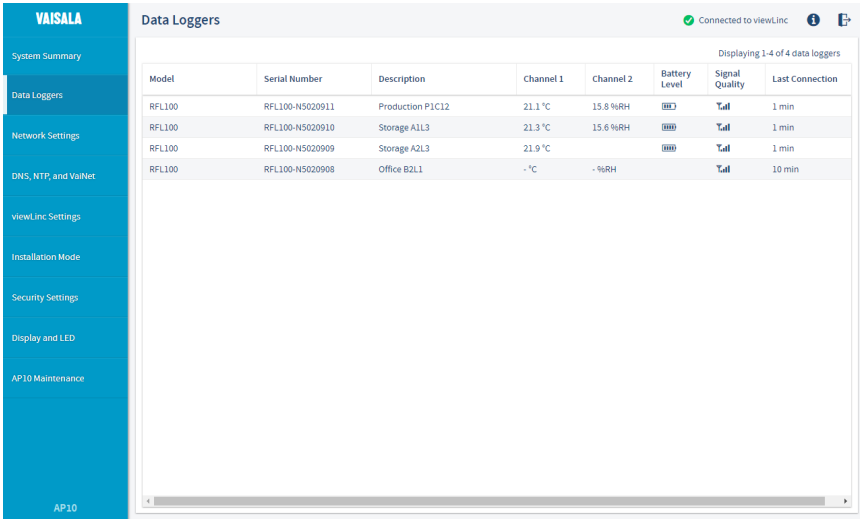

The screenshot shows the Vaisala web interface for an API0 access point. The left sidebar contains navigation options: System Summary, Data Loggers (selected), Network Settings, DNS, NTP, and VaiNet, viewLinc Settings, Installation Mode, Security Settings, Display and LED, and API0 Maintenance. The main content area is titled 'Data Loggers' and shows 'Connected to viewLinc'. Below the title, it says 'Displaying 1-4 of 4 data loggers'. A table lists the following data loggers:

Model	Serial Number	Description	Channel 1	Channel 2	Battery Level	Signal Quality	Last Connection
RFL100	RFL100-N5020911	Production P1C12	21.1 °C	15.8 %RH		Full	1 min
RFL100	RFL100-N5020910	Storage A1L3	21.3 °C	15.6 %RH		Full	1 min
RFL100	RFL100-N5020909	Storage A2L3	21.9 °C			Full	1 min
RFL100	RFL100-N5020908	Office B2L1	- °C	- %RH		Full	10 min

Figure 13 Web Interface Data Loggers Page

After a data logger has been out of contact for more than 32 minutes, it will be removed from the list of connected data loggers. Since the access point only removes one data logger from the list during one scan cycle, data loggers that are out of contact may remain on the list even longer. It is possible for data loggers to be listed on more than one access point simultaneously when they are changing access points.

Settings Pages

VAISALA

System Summary

Data Loggers

Network Settings

DNS, NTP, and VailNet

viewLink Settings

Installation Mode

Security Settings

Display and LED

AP10 Maintenance

AP10

Network Settings

Connected to viewLink

IP address type

- Dynamic IP address (DHCP)
- Static IP address

IP address: 192.168.137.182

Subnet mask: 255.255.255.0

Default gateway: 192.168.137.1

Save Undo Changes

Configuring Network Settings

Select the correct **IP address type** for the network:

- Select **Dynamic IP address (DHCP)** if you are connecting the access point to a network that assigns network configuration settings automatically (default).
- Select **Static IP address** to configure network settings manually. Using the information supplied by your IT administrator, enter the **IP address**, **Subnet mask**, and **Default gateway**.

When you select **Save**, the new settings are saved and you are logged out of the web interface. If the IP address of the access point changes as a result of the new settings, you must enter **https://** and the new IP address in the address field of your browser to be able to access the web interface again. You can always check the current IP address of the access point from its local display.

Note: Entering incorrect addresses may cause the access point to become unresponsive. To recover, power cycle the access point and reconnect to the web interface.

Figure 14 Web Interface Network Settings

VAISALA

System Summary

Data Loggers

Network Settings

DNS, NTP, and VailNet

viewLink Settings

Installation Mode

Security Settings

Display and LED

AP10 Maintenance

AP10

DNS, NTP, and VailNet Ch...

Connected to viewLink

DNS 1: 192.168.137.1

DNS 2:

NTP 1: 0.pool.ntp.org

NTP 2: 1.pool.ntp.org

NTP 3: 2.pool.ntp.org

NTP 4: 3.pool.ntp.org

VailNet channel: 6

Save Undo Changes

DNS, NTP, and VailNet Settings

Changed settings are applied immediately when you select **Save**.

Configuring DNS Servers Manually

You must set the addresses of Domain Name System (DNS) servers manually if you have defined a static IP address for the access point. Enter the IP addresses of the DNS servers in fields **DNS 1** and **DNS 2**. You must enter at least one DNS server.

Configuring NTP Servers

Access point must have a connection to at least one Network Time Protocol (NTP) server to provide the access point with accurate time. By default, the access point has four NTP servers defined. The default servers are in the internet, so internet access from the network is required to use them.

To add your own local NTP server to the list (recommended), replace one of the default servers hostnames with the IP address or hostname of the server.

Configuring VailNet Channel Number

Assign a unique VailNet channel number for each access point in an area. If you have more than eight access points, make sure that access points that are in range of each other do not have the same number.

Note: If you change the VailNet channel number, all data loggers that are currently connected to this access point will lose connection. They will automatically rejoin the system, but their connection to viewLink Enterprise Server will be temporarily interrupted.

Figure 15 Web Interface DNS, NTP, and VailNet Settings Page

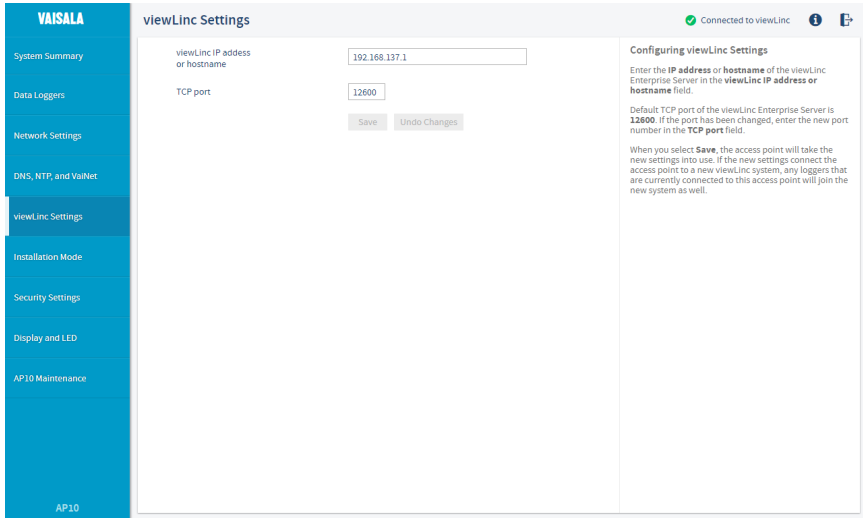

Figure 16 Web Interface viewLinc Settings Page

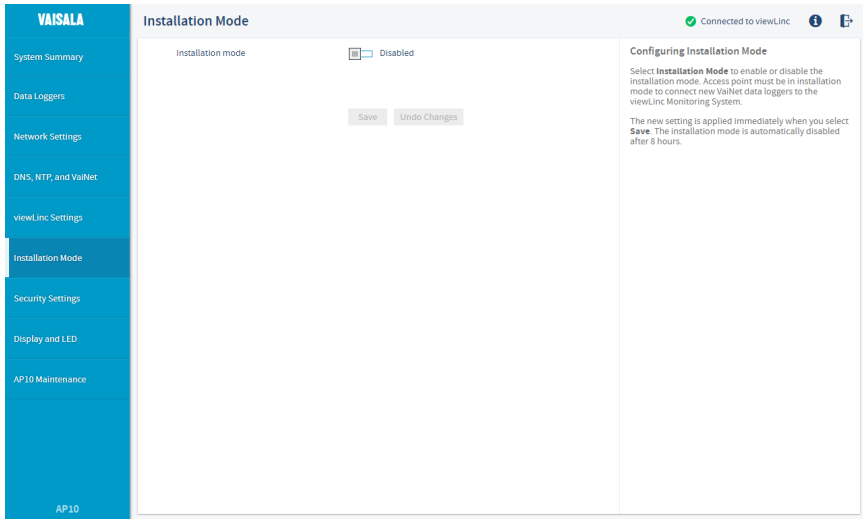

Figure 17 Web Interface Installation Mode Settings Page

VAISALA

System Summary

Data Loggers

Network Settings

DNS, NTP, and Vainet

viewLinc Settings

Installation Mode

Security Settings

Display and LED

AP10 Maintenance

AP10

Security Settings

Connected to viewLinc

Change Password

Password is the same for both web and access point display.

Current password:

New password:

Confirm new password:

Web Interface

Session timeout Disabled

Access Point Display

Password query Disabled

Ask for password when using touch display.

Security Settings

The new settings are applied immediately when you select **Save**.

Changing the Password

Enter the **Current password**, and the new password twice to confirm. Minimum password length is 9 characters. Allowed characters are **0-9** and **a-z**.

The default password is **ap123456**.

Web Interface Session Timeout

If **Session timeout** is enabled, the web interface session will end automatically after it has been idle for the amount of minutes defined in the **Timeout after** field.

Password Query for Access Point Display

If **Password query** is enabled, you must enter the password before you can use the touch interface. You must enter the password again when the touch interface has been idle for more than five minutes.

Figure 18 Web Interface Security Settings Page

Vaisala recommends changing the default password. Minimum password length is 8 characters. Allowed characters are **0-9** and **a-z**.

VAISALA

System Summary

Data Loggers

Network Settings

DNS, NTP, and Vainet

viewLinc Settings

Installation Mode

Security Settings

Display and LED

AP10 Maintenance

AP10

Display and LED

Connected to viewLinc

AP10 Display

Display On

Brightness

25 %

50 %

100 %

AP10 LED

LED On

Brightness

25 %

50 %

100 %

Changing Display and LED Settings

The new settings are applied immediately when you select **Save**.

Changing Display Settings

Select **Display** to turn the local display of the access point on or off. When the display is off, touching it turns it on temporarily. The display will turn off again when the touch interface has been idle for more than 30 seconds.

The selected **Brightness** setting is used when the display is on.

Changing LED Settings

Select **LED** to turn the LED of the access point on or off.

The selected **Brightness** setting is used when the LED is on.

Figure 19 Web Interface Display and LED Settings Page

AP10 Maintenance

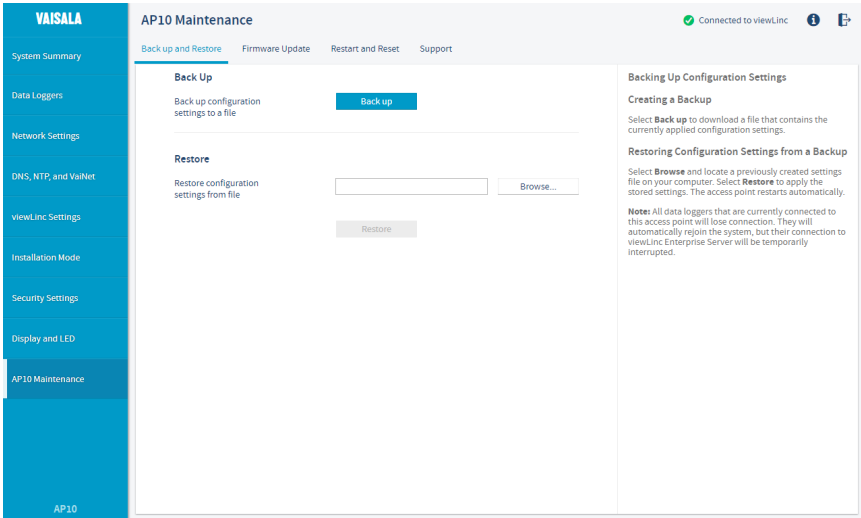

Figure 20 Web Interface Backup and Restore Page

You can back up and restore your current configuration settings on the **Back up and Restore** page. This is convenient for testing settings, and copying the same settings to several access points. However, make sure to use a different VaiNet channel on each access point in one location.

The screenshot shows the Vaisala AP10 Maintenance web interface. The left sidebar contains navigation options: System Summary, Data Loggers, Network Settings, DNS, NTP, and VailNet, viewLinc Settings, Installation Mode, Security Settings, Display and LED, and AP10 Maintenance (highlighted). The main content area is titled 'AP10 Maintenance' and has tabs for 'Back up and Restore', 'Firmware Update' (selected), 'Restart and Reset', and 'Support'. Under 'Firmware Update', the 'Access point firmware' is listed as 'release v.2.0.0'. There is an 'Update from file' section with a text input field and a 'Browse...' button. Below this is an 'Update' button. On the right, the 'Updating Access Point Firmware' section contains instructions: 'Select **Browse** and locate the new firmware file on your computer. Select **Update** to start updating the firmware.' It also includes a note: 'The update may take up to 15 minutes, and the access point will automatically restart after it is done. Do not unplug or attempt to use the access point during the update. After the update is complete, verify that the access point is still properly configured for your system. New settings may be available, and old settings may have changed.' A final note states: 'Note: All data loggers that are currently connected to this access point will lose connection. They will automatically rejoin the system, but their connection to viewLinc Enterprise Server will be temporarily interrupted.'

Figure 21 Web Interface Firmware Update Page

For firmware update procedure, see [Updating AP10 Firmware \(page 35\)](#).

The screenshot shows the Vaisala AP10 Maintenance web interface, specifically the 'Restart and Reset' section. The left sidebar is the same as in Figure 21. The main content area has tabs for 'Back up and Restore', 'Firmware Update', 'Restart and Reset' (selected), and 'Support'. Under 'Restart and Reset', there are two main sections: 'Restart Access Point' with a 'Restart' button, and 'Reset Settings' with a 'Reset' button. The 'Reset Settings' section includes the text: 'All settings will be reset to factory defaults.' followed by a list of checkboxes: 'Keep network settings (IP address, subnet mask, and default gateway)', 'Keep DNS, NTP, and VailNet settings', 'Keep viewLinc settings (IP address, TCP port)', 'Keep password', 'Keep certificates and keys', and 'Keep language settings'. On the right, the 'Restart and Reset' section contains the following text: 'Restarting the Access Point' with the instruction 'Select **Restart** to restart the access point.' and a note: 'Note: All data loggers that are currently connected to this access point will lose connection. They will automatically rejoin the system, but their connection to viewLinc Enterprise Server will be temporarily interrupted.' Below this is the 'Resetting Settings' section with the instruction: 'Select **Reset** to revert the access point to its default settings. Note that you can select to keep some settings and reset everything else. After the settings are reset, wait for the user interfaces to restart.' A final note states: 'If the IP address of the access point changes when the settings are reset, you must enter **https://** and the new IP address in the address field of your browser to be able to access the web interface again. You can always check the current IP address of the access point from its local display.'

Figure 22 Web Interface Restart and Reset Page

Restart and Reset page can be used to restart the access point, or reset all or some of its settings. If you reset all settings, the installation wizard starts when the access point boots up. Complete the wizard to make the access point operational again. If you select to keep some settings, you must go through the settings manually to check that everything is correctly configured for your system.

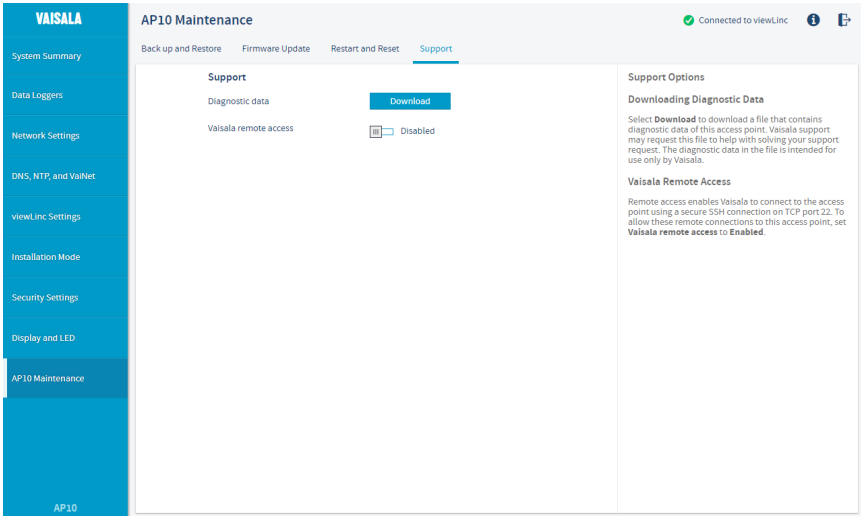

Figure 23 Web Interface Support Page

If Vaisala support requests a diagnostic data package from your API0, you can retrieve it from the **Support** page.

Starting from firmware version 2.0.0, this page also has a switch for disabling **Vaisala remote access** connections to this access point. Remote access enables Vaisala to connect to the access point using a secure SSH connection on TCP port 22.

6. Maintenance

6.1 Cleaning AP10



- Lint-free cloth
- Isopropyl alcohol (70%)



Do not spray anything directly on the AP10.

- ▶ 1. Moisten some lint-free cloth with isopropyl alcohol (70 %).
2. Wipe the access point and its antenna.

6.2 Updating AP10 Firmware



- Computer with a supported web browser (Google Chrome™, Microsoft® Internet Explorer® 11, or Microsoft Edge™)
- AP10 firmware update file from Vaisala



All data loggers that are currently connected to this access point will lose connection. They will automatically rejoin the system, but their connection to viewLinc Enterprise Server will be temporarily interrupted.

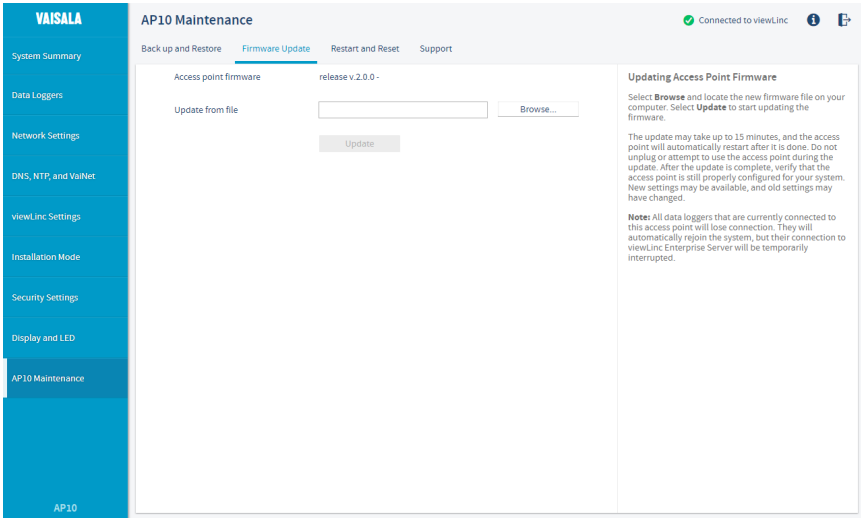

Figure 24 Firmware Update Page in Web Interface

- ▶ 1. Before starting the firmware update, read the release notes that are included with the file. The release notes contain a summary of important changes and possible compatibility requirements.
2. Restart the API0:
 - a. Log in to the web interface of the API0. See [Accessing the Web Interface \(page 26\)](#).
 - b. Select **API0 Maintenance > Restart and Reset > Restart > Restart**.
3. Wait for the restart to complete and log in again to the web interface.
4. Select **API0 Maintenance > Firmware Update**.
5. Check the currently installed firmware version. If the version of your update file is higher than the installed version, continue with the update.
6. Select **Browse** and locate the firmware file on your computer.
7. Select **Update** to start the firmware update process. Confirm the update by selecting **Update** again.
 The update will typically complete within 15 minutes, and the access point will automatically restart after it is done. Do not unplug or attempt to use the access point during the update.

8. After the update is successfully completed:
 - a. Log in again to the web interface.
 - b. Select **AP10 Maintenance > Firmware Update** and verify that the firmware version has been updated.
 - c. Verify that the access point is still properly configured for your system. New settings may be available, and old settings may have changed.



If the update appears to be stuck and you have already waited for 15 minutes, or if you receive a message indicating the update has failed (this can happen due to network connectivity problems):

1. Restart the AP10 and log in again to the web interface.
2. Check the current firmware version from the **AP10 Maintenance > Firmware Update** page. If the firmware version has not been updated (update was not successful), try the update again. If you have already tried twice, continue to the next step.
3. Select **AP10 Maintenance > Back up and Restore > Back up** to back up your settings to a file.
4. Revert the AP10 back to factory settings; see [Performing a Factory Reset \(page 40\)](#). Note that doing this may change the IP address of the AP10, since network settings will also be reset.
5. Repeat the firmware update one more time. If the update still fails, contact Vaisala support.

7. Troubleshooting

7.1 Problem Situations

Table 5 Troubleshooting Table

Problem	Possible Cause	Solution
API0 cannot connect to viewLinc Enterprise Server. The following message is shown on the display: Not connected to viewLinc	API0 network settings are incorrect.	Check and correct network settings of API0. Verify that it can join the network.
	API0 does not have the address of the viewLinc Enterprise Server.	Check and correct viewLinc settings of API0.
	Firewall is blocking the viewLinc communication port.	Check that connections between API0 and viewLinc Enterprise Server are allowed on port 12600 (default).
	Network outage.	Check that the Ethernet connection cable is attached to the API0, and that the activity LEDs on the Ethernet connector are flashing. Contact your local IT support.
The following message is shown on the display: Not connected to NTP	API0 has just started up and it has lost accurate time during power off.	Wait for API0 to synchronize time with the NTP (Network Time Protocol) servers. See Time Synchronization (page 11) .
	API0 has been unable to synchronize time with any of the NTP servers on its list for more than three weeks.	Check the NTP settings and take corrective action so that at least one of the listed NTP servers is reachable by the API0. See Time Synchronization (page 11) .

Problem	Possible Cause	Solution
AP10 is in installation mode but data loggers are not connecting to it.	Data loggers have turned off their radio temporarily to conserve battery.	Wait patiently. Even normal connections take several minutes to complete. If a data logger has been out of contact with an access point for a long time, it may keep its radio off for up to eight hours.
	AP10 cannot start its radio communication because it does not have accurate time from a network time protocol (NTP) server.	Verify that the AP10 is configured to connect to the right NTP server. Make sure the NTP server is accessible from the network. Note that internet access is required to reach the default NTP servers.
Cannot log in to the web interface.	Incorrect username and/or password.	Enter the correct credentials. The user name is apadmin and the default password is ap123456 .
AP10 display turns off by itself.	Display has been configured to turn off automatically.	Check the display and LED settings of AP10 and configure as desired.
AP10 does not start up properly. The following message is shown on the display: Persistent storage failure	Filesystem of the AP10 has been corrupted.	Perform a factory reset. See Performing a Factory Reset (page 40) .

7.2 Verifying Operation of AP10

Perform this procedure to verify the normal operation of an AP10 access point. If you encounter problems or error messages, proceed as instructed in section [Problem Situations \(page 38\)](#).

- ▶ 1. Connect the Ethernet cable.
2. If the Ethernet cable does not provide power, connect the DC power supply:
 - a. Connect the plug to the power supply connector of AP10. Make sure the plug is oriented correctly and goes in all the way.
 - b. Rotate the power plug slightly to lock it to the connector.
 - c. Connect the power supply to the wall socket.

3. Monitor the startup from the display. At startup, the access point performs several checks to verify that its hardware, filesystems, and configuration are in order. If the startup completes normally, the basic views.
If startup encounters errors, it may be able to automatically correct them and continue normally. Filesystem errors are typically recoverable. However, configuration errors may be fatal and prevent normal startup.
4. Wait a minute for the basic view to update. There should be no error messages.
5. Touch the screen to verify the operation of the touchscreen.

7.3 Performing a Factory Reset



- Pen or a small flat-head screwdriver

Factory reset clears all user settings on the AP10. It is also necessary if the access point is unable to start up due to filesystem corruption.



All data loggers that are currently connected to this access point will lose connection. They will automatically rejoin the system, but their connection to viewLinc Enterprise Server will be temporarily interrupted.

- ▶ 1. If the AP10 is not on, power it up using the DC power supply and wait for it to complete the startup.
2. AP10 has a small button marked **Reset**. Push it using a pen or a small flat-head screwdriver, and hold it down. AP10 will reset. Continue pushing the button.
3. Release the button when the text **Performing factory reset...** appears.
4. Wait for the AP10 to complete the startup and show the installation wizard.
5. Before starting to use the AP10 after the factory reset, complete the installation wizard using the touchscreen interface.

8. Technical Data

8.1 AP10 Technical Specification

Table 6 Wireless

Property	Specification
Networking standards	Vaisala VaiNet
Modulation	LoRa™ chirp spread spectrum modulation
Output power	14 dBm (25 mW)
Antenna	Non-removable external antenna
Typical range (indoors)	At least 100 m (328 ft)
Maximum number of access points in an area	8
Frequency Bands	
Model AP10E	868 MHz (Europe)
Model AP10A	915 MHz (North America, Australia, and New Zealand)
Safety	
Electrical safety	EN/UL/IEC 61010-1
RF exposure	KDB 447498 (United States) RSS-102 Issue 5 (Canada)
EMC and Radio Standards	
EMC compliance	EN/IEC 61326-1, industrial environment
Model AP10E	ETSI EN 300 220-2 EN 301 489-1 EN 301 489-3
Model AP10A	FCC title 47 part 15.247 (FCC ID: 2A039-AP10A) ICE RSS-247 (IC: 23830-AP10A) AS/NZS 4268

Table 7 Operating Environment

Property	Specification
Operating environment	Indoor use

Property	Specification
Operating temperature	-20 ... +60 °C (-4 ... +140 °F)
Operating humidity	0 ... 90 %RH, non-condensing
Storage temperature	-20 ... +60 °C (-4 ... +140 °F)

Table 8 Inputs and Outputs

Property	Description/Value
Operating voltage using dedicated power supply connector	10 ... 30 VDC
PoE power class	Class 0
Power consumption	Max. 13 W
Internal clock	Synchronizes with Network Time Protocol (NTP) server
Supported devices	Up to 32 VaiNet compatible data loggers
Compatible viewLinc versions	5.0 and above
User interfaces	Web browser interface Local touchscreen interface
User interface languages	English, German, French, Portuguese, Spanish, Swedish, Chinese, Japanese
Ethernet Interface	
Supported standards	10BASE-T, 100BASE-TX
IPv4 address assignment	DHCP (automatic), static
Connectors	
Power supply connector	2.0 mm center pin locking type DC power jack
Service port	Micro-USB (2.0)
Expansion port	USB type A (2.0)
Ethernet	8P8C (RJ-45)

Table 9 Mechanical Specifications

Property	Specification
IP rating	IP30
Housing color	White
Mounting methods	Screws, tie-wrap

Property	Specification
Weight	350 g (12.3 oz)
Dimensions (H × W × D)	311 × 133 × 37 mm (12.24 × 5.24 × 1.46 in)
Materials	
Housing	PC/ABS blend
Display window	Polyester
Antenna	ABS

8.2 AP10 Spare Parts and Accessories

Table 10 Spare Parts and Accessories

Item	Order Code
Power supply for AP10	244784SP
Mounting kit	245679SP

8.3 AP10 Dimensions

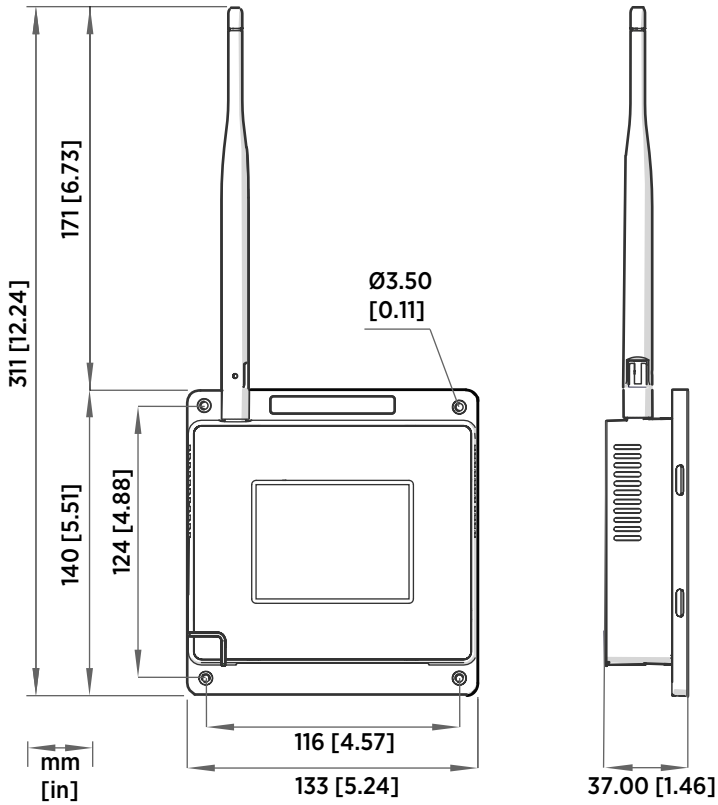

Figure 25 AP10 Access Point Dimensions

Technical Support



Contact Vaisala technical support at helpdesk@vaisala.com. Provide at least the following supporting information:

- Product name, model, and serial number
- Name and location of the installation site
- Name and contact information of a technical person who can provide further information on the problem

For more information, see www.vaisala.com/support.

Warranty

For standard warranty terms and conditions, see www.vaisala.com/warranty.

Please observe that any such warranty may not be valid in case of damage due to normal wear and tear, exceptional operating conditions, negligent handling or installation, or unauthorized modifications. Please see the applicable supply contract or Conditions of Sale for details of the warranty for each product.

Recycling



Recycle all applicable material.



Follow the statutory regulations for disposing of the product and packaging.

VAISALA

www.vaisala.com

