Instruction Manual PUC 24

Process monitoring device for clean rooms



halstrup - walcher GmbH

Stegener Straße 10
D-79199 Kirchzarten

Tel.: +49 (0) 76 61/39 63-0
Fax: +49 (0) 76 61/39 63-99

E-Mail: info@halstrup-walcher.de
Internet: www.halstrup-walcher.de

Table of Contents:

1 Validity and purpose of the instruction manual.....	4
2 Safety precautions.....	5
2.1 Appropriate use.....	5
2.2 Shipping, assembly, electrical connections and start-up.....	5
2.3 Troubleshooting, maintenance, repairs, disposal.....	5
2.4 Symbols.....	6
3 Device description.....	7
3.1 General functional description.....	7
3.2 Cyclic zero-point calibration.....	8
3.3 Display of measured values.....	8
3.4 Display and controls.....	9
3.5 Manual zero-point calibration.....	10
3.6 Connections.....	10
4 Assembly.....	12
5 Setting the parameters.....	16
5.1 Abbreviations used.....	17
5.2 Basic settings [SETTINGS].....	18
5.2.1 Language [SETTINGS / LANGUAGE].....	18
5.2.2 Changing the password [SETTINGS / NEW PASSWD].....	18
5.2.3 Measurement range of the internal pressure sensor [SETTINGS / MEAS. R.].....	18
5.2.4 External sensors (IN1 and IN2) [SETTINGS / CONF. EXTERN].....	19
5.2.5 Display [SETTINGS / DISPLAY].....	19
5.2.6 Signal [SETTINGS / SIGNAL].....	20
5.2.7 Acoustic signalling device [SETTINGS / SOUND].....	20
5.2.8 Decimal places display [SETTINGS / DECIMAL PL.].....	20
5.2.9 Reset the device [SETTINGS / RESET].....	21
5.2.10 Recall the delivery state [SETTINGS / DELIVERY ST.].....	21
5.3 Scaling and limits [VALUES].....	22
5.3.1 Scaling [VALUES / SCALE].....	22
5.3.2 Limits [VALUES / WARNING].....	22
5.4 Filter setting [FILTER].....	24
5.5 Relays [RELAY].....	25
5.5.1 Switching conditions and relay test [RELAY / COND. TEST].....	25
5.5.2 Relay activation and deactivation delays [RELAY / TIME REL.].....	26
5.5.3 Alarm acknowledgement [RELAY / ACKNOWLEDGE].....	27

6 RS232 Interface.....	28
6.1 List of RS232 commands	28
6.1.1 Commands for Configuration.....	28
6.1.2 Commands for reading the measured values and the status values.....	31
6.1.3 Other commands.....	32
6.2 Error codes.....	32
6.3 Assignment of the RS232 connector	33
6.4 Interface configuration	34
6.5 Configuration software.....	34
7 Profibus DP interface.....	38
7.1 Profibus DP address	38
7.2 Terminating resistors	38
7.3 Modules.....	39
7.4 Setting the parameters of the PUC 24 as a Profibus slave	41
7.5 Assignment of the Profibus connector	42
8 Adjusting the PUC 24 [TEACH]	43
8.1 Adjusting the internal pressure transmitter.....	43
8.2 Adjusting the analogue inputs and outputs	44
9 Care instructions for PUC 24	44
10 Technical data	45
11 Troubleshooting.....	45
12 Dimension drawing	46
13 Menu tree	47
14 Ranges of values and default settings	50

1 Validity and purpose of the instruction manual

This instruction manual applies to the PUC 24 starting with software version 3.4.

The instruction manual explains the operation and handling of the process monitoring device. Improper use of this device or failure to follow these instructions may cause injury to people or equipment damage. Every person who uses this device must therefore read the manual and understand the possible risks. The instruction manual, and in particular the safety precautions contained therein, must be followed carefully. **Contact the manufacturer if you do not understand any part of this instruction manual.**

Handle this instruction manual with care:

- It must be readily available throughout the lifecycle of the device.
- It must be provided to any individuals who assume responsibility for operating the device at a later date.
- It must include any supplementary materials provided by the manufacturer.

The manufacturer reserves the right to continue developing this device model without documenting such development in each individual case. The manufacturer will be happy to determine whether this manual is up-to-date.

Conformity

This device is state of the art. It complies with the legal requirements of EC directives. This is shown by the CE mark.



© 2010

The manufacturer owns the copyright to this instruction manual. It contains technical data, instructions and drawings detailing the device's features and how to use it. It must not be copied either wholly or in part or made available to third parties.

2 Safety precautions

2.1 Appropriate use

The PUC24 is used to test pressure, temperature and humidity.

Always observe the operating requirements — particularly the permissible supply voltage — indicated on the rating plate and in the “Technical data” section of this manual.

The device may only be handled as indicated in this manual. Modifications to the device are prohibited. The manufacturer is not liable for damages caused by improper use or failure to follow these instructions. Violations of this type render all warranty claims null and void.

2.2 Shipping, assembly, electrical connections and start-up

Do not close the pressure ports during shipping. Changes in barometric pressure may damage devices with low measurement ranges.

Assembly and the electrical connections should only be handled by professionals. They should be given proper training and be authorized by the operator of the facility.

The instrument may only be operated by appropriately trained individuals who have been authorized by the operator of the facility.

The functional test must not be performed using compressed air or breath because otherwise devices with low measurement ranges could be damaged.

Measurement errors may occur if the instrument is not kept protected from sunlight. Specific safety precautions are given in individual sections of this manual.

The first step is to create a recess in the wall (approx. 232 x 132 mm) at the site of installation using the hole template provided. See section entitled “Assembly” for additional assembly steps.

The instrument must be grounded at the ground terminal.

2.3 Troubleshooting, maintenance, repairs, disposal

The individual responsible for the electrical connections must be notified immediately if the device is damaged or if malfunctions occur that cannot be corrected as indicated in the section entitled “Troubleshooting”.

This individual must take the instrument out of service until the malfunction has been corrected and ensure that it cannot be used unintentionally.

Always unplug the power cord before opening the device!

This instrument requires no maintenance.

Only the manufacturer may perform repairs that require the housing to be opened.

The electronic components of the device contain environmentally hazardous materials and materials that can be reused. The device must therefore be sent to a recycling plant when you no longer wish to use it. Compliance with the environmental codes of your particular country is mandatory.

2.4 Symbols

This instruction manual uses the following symbols to emphasize references to the operation and hazards when using the system:



WARNING! This warns you of a potential hazard that could lead to bodily injury up to and including death if the corresponding instructions are not followed.



CAUTION! This warns you of a potential hazard that could lead to significant property damage if corresponding instructions are not followed.



INFORMATION! This indicates that the corresponding information is important for operating the device properly.



MENU PATH: In section 5 (entitled “Setting the parameters”), the menu paths are shown using brackets (e.g., [VALUES / WARNING]).

3 Device description

3.1 General functional description

The PUC 24 is a microprocessor-controlled process monitoring device designed for use in clean rooms. It has one internal differential pressure sensor and two analogue inputs (0 ... 10 V and 0 (4) ... 20 mA each) for connecting external sensors. One temperature and one humidity sensor or two additional pressure sensors may be connected to these two ports. The signal of the internal pressure sensor can be provided by way of the OUT output as a current or voltage value (0 ... 10 V and 0 (4) ... 20 mA).

The three process values (e.g., pressure, temperature and humidity) are shown on the integrated display. At the same time, the limits, which can be set as parameters, are monitored and an acoustic alarm is triggered if a value moves outside its limits. In addition, two relay contacts (changeover contacts) represent these alarm states (in some variants of the PUC 24 these relay contacts are not present). These contacts may be used, for example, to drive external signal devices (strobe light or horn) or to feed the alarm signal to a central building control system. As an option, confirming the alarm by way of the push of a key can be set as a parameter.

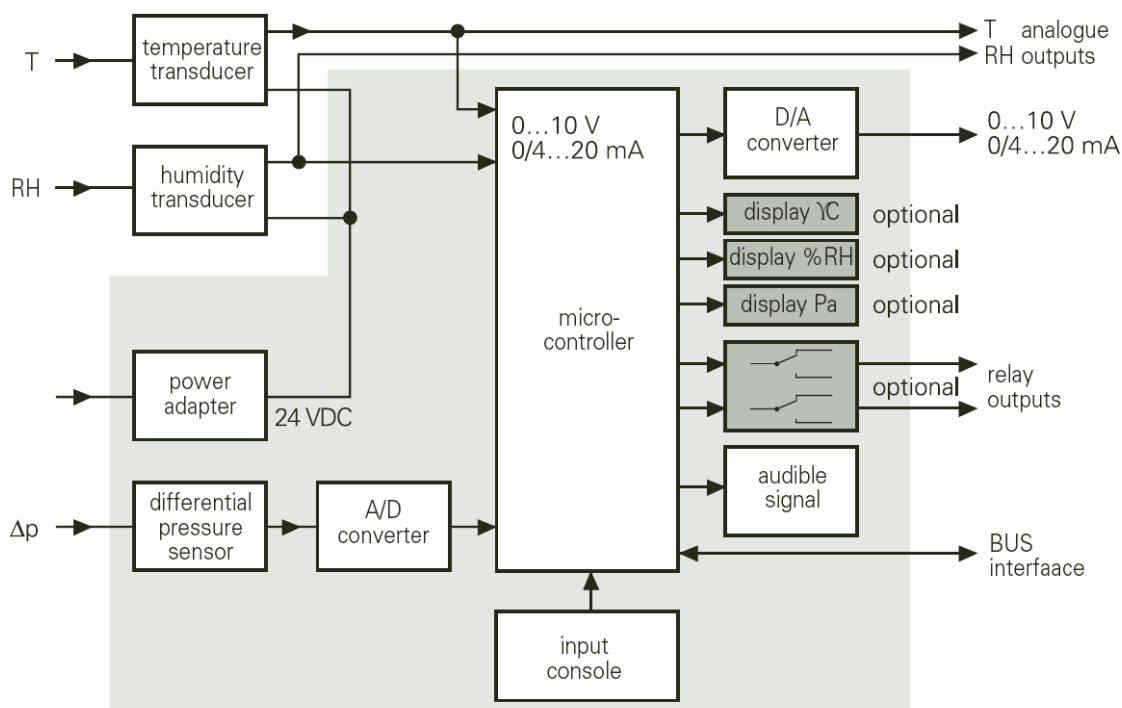

Fig. 1: Block diagram of the PUC 24

The PUC 24 can be supplied with a Profibus DP interface for connection to the central building control system. In this case, the PUC 24 is integrated into the Profibus as a slave. It is possible to read all values of the PUC via the Profibus or to use the PUC as a display and an evaluation device in that the process signals (Pressure/IN 1/IN 2) are not provided by way of the internal pressure sensor or the analogue inputs but rather via the Profibus.

The parameters of the PUC 24 are set in a menu-driven manner using the four integrated keys (see section 5 entitled "Setting the parameters") or using the Profibus.

The PUC24 has an internal overpressure safeguard that protects the precision pressure measurement capsule from damage.

Optionally a connection of the PUC 24 via a serial RS232C interface is also possible, this allows configuring the PUC 24 (alternatively to the configuration with the help of the integrated keys in the front plate) as well as reading the measured values and triggering certain actions (e.g. zero-point calibration) with the help of a PC. A PC configuration software also addresses these functions, which might serve as a remote station to the PUC 24 with RS232 interface.

3.2 Cyclic zero-point calibration

External influences such as temperature, position or ambient pressure can shift the device's zero point, i.e., the value displayed when the pressure ports are open. Calibration is the process by which the device automatically registers this shift and figures it into the currently displayed pressure. During this process, "CALIBRATION" appears in the top line of the display. Calibration is always performed after power is applied to the PUC 24. As the PUC 24 must frequently adjust to the ambient temperature after power is applied (e.g., a new installation), calibration is performed every 15 minutes in the following hour. After this, a cyclic calibration is performed every hour. If the PUC 24 is in the parameter mode, calibration is postponed until after the parameters are set.



During the zero-point calibration procedure, the PUC 24 does not react to the press of a key. In this case, please wait a few seconds until the end of the calibration procedure (e.g., confirmation of an alarm).

If the PUC 24 has an RS232 or Profibus DP interface, the cyclic calibration can be replaced by a calibration command as an alternative. This ensures that no measured values are lost during critical process phases because of a calibration procedure.

3.3 Display of measured values

The display is capable of showing three measured values:

- 1st line - pressure (measured by the internal pressure sensor)
- 2nd line - value of the signal present at the input IN1
(dependent on the sensor connected: temperature or pressure)
- 3rd line - value of the signal present at the input IN2
(dependent on the sensor connected: relative humidity or pressure)

If the signal wanders outside the set limits (alarm), the corresponding line alternates between displaying the measured value and a blinking arrow. The arrow pointing upward indicates that the upper limit has been exceeded. An arrow pointing downward indicates that the signal has dropped below the lower limit.

If the inputs IN1 and/or IN2 are not used, the corresponding lines can be blanked on the display (see section 5 entitled "Setting the parameters"). The internally measured pressure can also be blanked. In this case additionally no zero-point calibration takes place.

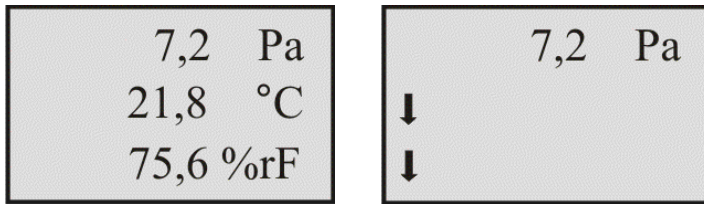

Fig. 2: Alternating display of the temperature and humidity showing that the values have dropped below the limits.

3.4 Display and controls

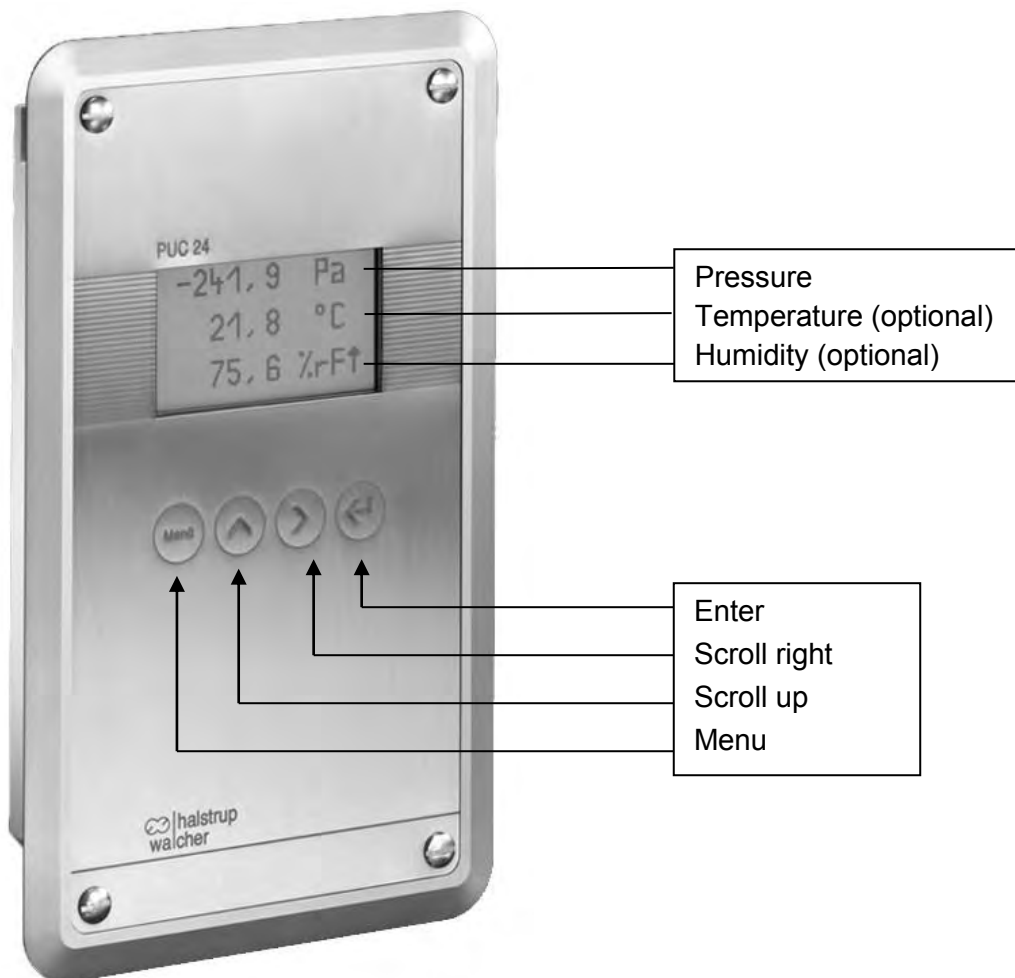

Fig. 3: Front of the PUC 24

The process monitoring device has an LCD display that can show three measured values. The integrated keys are used to confirm alarms and for the menu-driven setting of the parameters for the PUC 24. Functions are dynamically assigned to the keys.

3.5 Manual zero-point calibration

Additionally to the cyclic zero-point calibration (see section 3.2 entitled “Cyclic zero-point calibration”) the zero-point calibration can also be initiated at any time manually, as long as the device is in display mode. To start the calibration, press “Enter”. Thereon the question “Calibrate ?” with the selections “No” and “Yes” appears. By default, “No” is selected. Now with the keys “Scroll up” or “Scroll right” change to “Yes” and confirm with “Enter”. Then the zero-point calibration will be started.

3.6 Connections

Terminal	Connection description	Description
1	OUT I	Analogue current output (internal pressure sensor)
2	OUT -	Chassis ground for the analogue output (internal pressure sensor)
3	OUT U	Analogue voltage output (internal pressure sensor)
4	OUT EARTH	Cable shield (internal pressure sensor)
5	IN2 I	Analogue current input (humidity or pressure)
6	IN2 U	Analogue voltage input (humidity or pressure)
7	IN2 -	Chassis ground connection for IN2
8	IN2 +	+24VDC supply for IN2
9	IN1 I	Analogue current input (temperature or pressure)
10	IN1 U	Analogue voltage input (temperature or pressure)
11	IN1 -	Chassis ground connection for IN1
12	IN1 +	+24VDC power supply for IN1
13	GND	PUC 24 chassis ground
14	VCC	PUC 24 supply voltage (+24 V DC)

Table 1: Terminal assignment, control line connector

Terminal	Connection description	Description	
1	EARTH	Ground connection	
2	RL1_NO	Normally open contact	Relay 1
3	RL1_Common	Common	
4	RL1_NC	Normally closed contact	
5	RL2_NO	Normally open contact	Relay 2
6	RL2_Common	Common	
7	RL2_NC	Normally closed contact	

Table 2: Terminal assignment, relay connector (in some variants of the PUC 24 the relay contacts and therefore also the relay connector are not present)

Pressure input port	Description
+P	Positive pressure
- P	Negative pressure

Table 3: Assignment of the pressure input ports



Use the “IN1 +” and “IN1 I” or the “IN2 +” and “IN2 I” connections if hooking up a sensor with a two-wire configuration. “IN1 +” (resp. “IN2 +”) is the supply of the sensor; “IN1 I” (resp. “IN2 I”) is the sensing input and the minus-pole of the sensor at the same time.



If the cable at the analog OUT connection is longer than 3 meters, a shielded cable must be used. The shield must be connected to the OUT EARTH connection.

Terminal assignment of the RS232 and the Profibus DP interface:

For the RS232 and the Profibus DP interface there are two possibilities respectively:

9-pole D-SUB-jack (female)
(top view from outside):

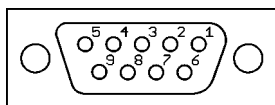

5-pole M12-jack (female, B-encoded)
(top view from outside):

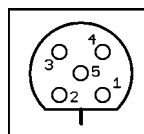

Fig. 4: RS232 resp. Profibus DP interface (9-pole D-SUB-jack, female or 5-pole M12-jack, female)

Terminal assignment:

- RS232: see section 6.3 entitled "Assignment of the RS232 connector"
- Profibus: see section 7.5 entitled "Assignment of the Profibus connector"

The PUC 24 variants with 9-pole D-SUB-jack differs to that effect, that the jack is either directly integrated in the housing or that it is located at the end of a flying leads cable which is lead out of the housing between both terminal connectors. However, the variant with D-SUB-jack is only suitable for wall thicknesses up to 5mm.

PUC 24 variants with M12-jack are only available with flying leads cable.

4 Assembly

The first step is to create a recess in the wall (approx. 232 x 132 mm) at the site of installation using the hole template provided.

The following materials will be required for the actual assembly of the PUC 24:

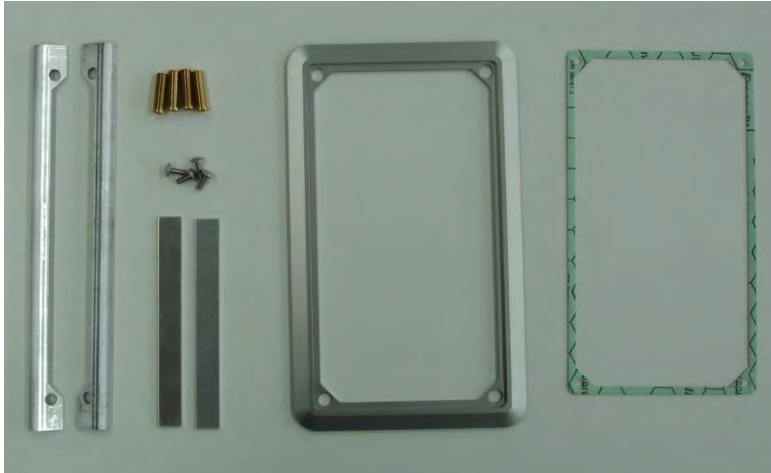

Fig. 5: Assembly material

The assembly takes place according the following steps:

- 1) For thin walls (<3 mm wall thickness), affix self-adhesive mounting strips along the top and bottom interior edges of the recess cut into the wall.
- 2) The next step is to secure the mounting frame in the wall recess (see following illustration) using the bolts and brackets provided:

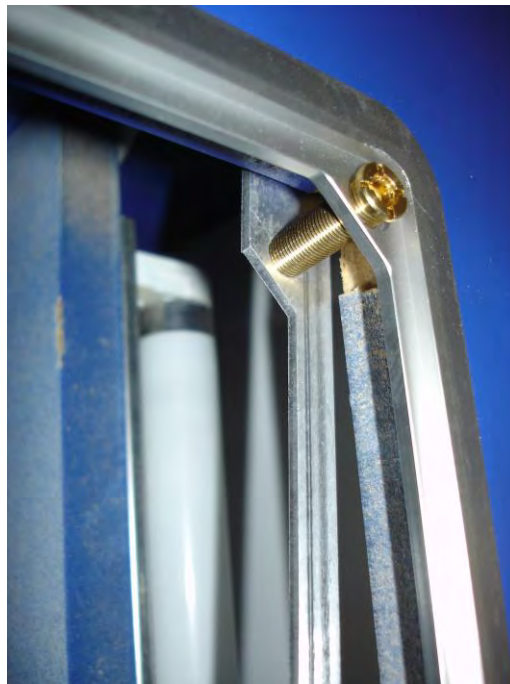

Fig. 6: Mount the frame and brackets

Screw in the bolts but do not tighten at first. Once all 4 bolts are in place, adjust the position of the frame if necessary and then tighten the bolts.

- 3) Remove the protective film from the sealing plate:



Fig. 7: Remove protective film from the sealing plate

- 4) Affix the sealing plate in the frame:

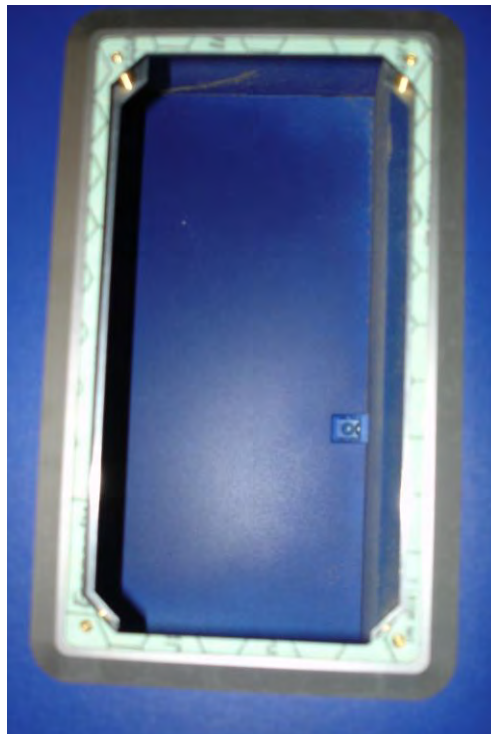

Fig. 8: Affix the sealing plate in the frame

- 5) Connect pressure tubing and electrical lines to the PUC 24.
Caution: The instrument must be grounded at the ground terminal!

- 6) Place the PUC 24 below the frame at an angle:



Fig. 9: Place the PUC 24 below the frame at an angle

- 7) Slide the PUC 24 upwards into the mounting frame and pivot into place:



Fig. 10: Slide the PUC 24 upwards into the mounting frame and pivot into place

- 8) Next, pull the PUC 24 back down and insert into the frame.
 9) Remove the protective film from the front plate.

- 10) Finally, mount the front plate onto the frame using 4 fillister head screws (please use a sufficiently wide screw driver):



Fig. 11: Mount front plate

5 Setting the parameters

Setting the PUC 24 parameters is menu-driven. The main menu is called using the “Menu” key. This is followed by a request to enter the password. As delivered, the password is set to “0000”. The password may be changed in the menu item “New password”. You may exit the menu at any time using the Menu key. If no key is pressed for about 2 minutes, the PUC 24 automatically returns to the display mode. If you exit the menu and call it again within 2 minutes, the password is not requested again. In the following sections, the individual menu items are explained in detail in the context of the menu tree (also see section 12 entitled “Menu tree”).

The function of the keys changes depending upon the active menu item.













Key	Name	Function	Effect
	Menu	Call or exit the menu for setting the parameters	
	Scroll up	Navigate	Selecting a submenu (moving the arrow)
		Set a parameter	Increasing the number at the cursor or changing properties
	Scroll right	Navigate	Selection
		Set a parameter	Scroll the cursor to the right (e.g., selection of the number of a parameter to be changed)
	Enter	Menu selection	Open the marked submenu
		Set a parameter	Confirm the value of a parameter

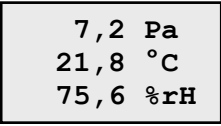

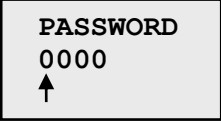



Table 4: Functions of the keys



In the following sections on menu description, it is assumed that the password has already been entered and confirmed and the main menu has already been displayed.

Example: Changing the password from 0000 to 2600

current display	Key(s)	Remark
		Call the menu to set parameters
		The default setting of the password is 0000 and can now be confirmed using “Enter”
	2 x 	Scroll up twice to mark the submenu [SETTINGS]
		Open the marked “Settings” submenu using “Enter”

LANGUAGE			Scroll once up to mark the next submenu item [SETTINGS / NEW PASSWD]
NEW PASSWD			Open the "New password" submenu item using "Enter"
NEW PASSWD 0000 ↑	2 x		Increase the number to 2 by scrolling up twice
NEW PASSWD 2000 ↑			Move to the next digit by scrolling right
NEW PASSWD 2000 ↑	6 x		Increase the number to 6 by scrolling up six times
NEW PASSWD 2600 ↑			Confirm using "Enter"
NEW PASSWD			Exit setting parameters using "Menu" and return to display mode
7,2 Pa 21,8 °C 75,6 %rH	<p>Caution: The new password is now needed to call the menu!</p>		

5.1 Abbreviations used

In showing the menu on the display, the following abbreviations are used:

German	English	Description
D	P	Pressure
1	1	Input "IN1"
1-T	1-T	Input "IN1" used for measuring temperature
1-D	1-P	Input "IN1" used for measuring pressure
2	2	Input "IN2"
2-F	2-H	Input "IN2" used for measuring humidity
2-D	2-P	Input "IN2" used for measuring pressure
OUT-D	OUT-P	Pressure output signal
HYST	HYST	Hysteresis
U	U	Voltage signal 0 ... 10 V
I-0	I-0	Current signal 0 ... 20 mA
I-4	I-4	Current signal 4 ... 20 mA

Table 5: Menu abbreviations used in the display

5.2 Basic settings [SETTINGS]

This menu branch contains the basic settings of the PUC 24.

5.2.1 Language [SETTINGS / LANGUAGE]

This submenu is used to select the display language.

Parameter description	Range of values	Default setting
Language	D - German GB - English	German

Table 6: Display language choices

5.2.2 Changing the password [SETTINGS / NEW PASSWD]

This submenu is used to change the password for enabling the parameter menu.

Parameter description	Range of values	Default setting
Password	Consists of 4 digits 0000 ... 9999	0000

Table 7: Password parameter

5.2.3 Measurement range of the internal pressure sensor [SETTINGS / MEAS. RANGE]

This parameter can specify the measurement range of the internal pressure sensor. The parameter is a function of the installed pressure sensor and is already set at the factory.

Parameter description	Range of values	Default setting
Measurement range	100 Pa 250 Pa	A function of the installed sensor

Table 8: Measurement range parameter



Setting the measurement range affects scaling, the limits and the characteristic curve of the internal pressure sensor. For this reason, the default setting should not normally be changed.

5.2.4 External sensors (IN1 and IN2) [SETTINGS / CONF. EXTERN]

External sensors may be connected to the inputs IN1 and IN2. The parameter informs the PUC 24 as to which sensor is connected to the corresponding input.

Parameter description	Range of values	Default settings
External sensors	IN1 – Temperature; IN2 – Humidity IN1 – Temperature; IN2 – Pressure IN1 – Pressure; IN2 – Humidity IN1 – Pressure; IN2 – Pressure	IN1 – Temperature IN2 – Humidity

Table 9: Possible settings for the external sensors

The units of the values shown in the display are adjusted automatically (temperature in °C, humidity in %rH, pressure in Pa). The units of a pressure display can be subsequently changed to hPa or mbar in the following “Display” submenu.

5.2.5 Display [SETTINGS / DISPLAY]

In the default setting, the display shows three values:

- Pressure
- Temperature
- Humidity

There are three submenus for these parameters. The display of each individual value can be blanked in these submenus (blinking of the entire line). This makes sense if no sensor is connected to the corresponding input or the internal pressure sensor is not used. If the value represents a pressure, the units can be selected (Pa, hPa or mbar). The range of values for the corresponding channel depends on the setting in the menu branch “CONF. EXTERN” that was used to specify which sensor is connected to the corresponding input.

Channel *	Parameter description	Range of values	Default setting
INT. PRESS. IN1-P IN2-P	Units of pressure for the display of the internal or externally connected sensors	Pa hPa mbar OFF - no display	Pa
IN1-T IN2-H	Whether the display is blanked or not	ON OFF	ON

Table 10: Display settings

* The channels are displayed according to the selection made under “CONF. EXTERN”.

5.2.6 Signal [SETTINGS / SIGNAL]

This submenu is used to specify the type for the analogue pressure output signal and the analogue input signals IN1 and IN2 to the connected sensor.

Input/output	Parameter description	Range of values	Default setting
OUT-P	Signal type (current signal or voltage signal)	U 0 ... 10 V	I-4
IN-1		I-0 0 ... 20 mA	
IN-2		I-4 4 ... 20 mA	

Table

11: Display settings

5.2.7 Acoustic signalling device [SETTINGS / SOUND]

The internal acoustic signalling device generates, in the event of alarm, an intermittent signal and a brief signal every time a key press is registered. The alarm signal can be confirmed by pressing any key (even if the parameter “Alarm acknowledgement” in the relay menu is not set). The pulse duration and separation of the intermittent alarm signal are set using the “LENGTH” parameter. The set length also determines the alternating interval between showing the alarm and the measured values on the display (in the case of measured values that have gone outside their limits, see section 3.3 entitled “Display of measured values”). The internal acoustic signalling device can be activated or deactivated.

Submenu	Parameter description	Range of values	Default setting
ON or OFF	Activation or deactivation, respectively, of the acoustic signalling device	ON - activated OFF - deactivated	ON
LENGTH	Pulse duration and pulse separation	0.1 ... 5 s	0.5 s

Table 12: Parameter description for the acoustic signalling device

5.2.8 Decimal places display [SETTINGS / DECIMAL PL.]

It can be specified separately for the internally measured pressure and the two inputs IN1 and IN2 whether the measured value should be shown on the display with or without a decimal place.

Parameters	Range of values	Werkseinstellung
INT. PRESS.	ON - Shown with decimal places OFF - Shown without decimal places	ON
IN1-T		
IN1-P		
IN2-H		
IN2-P		

Table 13: Decimal places display parameter description



If the units of mbar or hPa have been set for a pressure value, this value can only be displayed with a decimal place.

5.2.9 Reset the device [SETTINGS / RESET]

The PUC 24 will be resetted completely (this is equivalent switching off and on again the power supply of the device). The Profibus interface (for devices with Profibus DP interface) is also initialized. The menu settings stay unchanged.



Resetting the device might for example be useful if a new address is being set with the help of the both rotary switches. After the reset the new address is active.

5.2.10 Recall the delivery state [SETTINGS / DELIVERY ST.]

According the actual configured measurement range (± 100 Pa or ± 250 Pa) all menu settings are reset to the delivery state and being saved. Subsequently the PUC 24 will be resetted completely (this is equivalent switching off and on again the power supply of the device). The Profibus interface (for devices with Profibus DP interface) will also be initialized.

5.3 Scaling and limits [VALUES]

The PUC 24 is adjusted for the sensors used and the limits set for the alarm signals in the “VALUES” menu.

5.3.1 Scaling [VALUES / SCALE]

The measurement ranges of the connected sensors are set for the PUC 24 in this menu branch. “VALUE BOT” represents the measured value at 0(4) mA or 0 V. For “VALUE TOP”, the measured value for the analogue signal (20 mA or 10 V) must be entered.

The output signal can be adjusted in the same manner for the pressure measured using the internal sensor.



Please make sure that the VALUE TOP is larger than the VALUE BOT. If both new values are positive, the upper value must be set first. If both new values are negative, the lower value must be set first (always assuming that the old values have been according the delivery state). In case it is tried to enter a value for the upper value which is equal or lower than the actual lower value, the entered value is set to the actual lower value, increased by 0.1 Pa (°C, %rH). In case it is tried to enter a value for the lower value which is equal or higher than the actual upper value, the entered value is set to the actual upper value, decreased by 0.1 Pa (°C, %rH). The calculated value will then be shown in the display for further editing, the value won't be stored yet.

Input / sensor	Value	Range of values	Default setting
OUT-P	VALUE TOP	-120 ... +120 Pa * -300 ... +300 Pa **	+100 Pa * / +250 Pa **
	VALUE BOT	-120 ... +120 Pa * -300 ... +300 Pa **	-100 Pa * / -250 Pa **
IN 1-T	VALUE TOP	-800 ... +800 °C	60 °C
	VALUE BOT	-800 ... +800 °C	5 °C
IN 1-P	VALUE TOP	-300 ... +300 Pa	+100 Pa * / +250 Pa **
	VALUE BOT	-300 ... +300 Pa	-100 Pa * / -250 Pa **
IN 2-H	VALUE TOP	0 ... 800 %rH	75 %rH
	VALUE BOT	0 ... 800 %rH	0 %rH
IN 2-P	VALUE TOP	-300 ... +300 Pa	+100 Pa * / +250 Pa **
	VALUE BOT	-300 ... +300 Pa	-100 Pa * / -250 Pa **

Table 14: Scaling parameter description

* Value applies to a PUC 24 with an internal ±100 Pa sensor

** Value applies to a PUC 24 with an internal ±250 Pa sensor

5.3.2 Limits [VALUES / WARNING]

The PUC 24 monitors the measured values and can trigger an alarm if the limit is dropped below or exceeded. The upper and lower limits and hysteresis can be set for each measured value in this menu branch. The hysteresis is identical for both limits and ensures that, in the case of measured values fluctuating around the limit, an alarm is not triggered again and again (see Fig. 12).

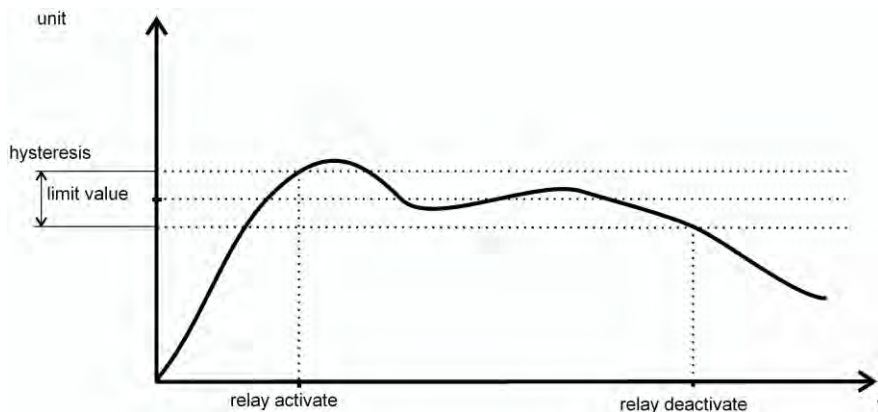

Fig. 12: Switching points of the relay considering hysteresis

Example: With an upper limit of 100 and a hysteresis of 10, the alarm is triggered at 105 and reset again at 95.



Please make sure that the VALUE TOP is larger than the VALUE BOT. If both new values are positive, the upper value must be set first. If both new values are negative, the lower value must be set first (always assuming that the old values have been according the delivery state). In case it is tried to enter a value for the upper value which is equal or lower than the actual lower value, the entered value is set to the actual lower value, increased by 0.1 Pa (°C, %rH). In case it is tried to enter a value for the lower value which is equal or higher than the actual upper value, the entered value is set to the actual upper value, decreased by 0.1 Pa (°C, %rH). The calculated value will then be shown in the display for further editing, the value won't be stored yet.

Input / sensor	Value	Range of values	Default setting
Internal pressure	VALUE TOP	-120 ... +120 Pa * -300 ... +300 Pa **	+100 Pa * / +250 Pa **
	VALUE BOT	-120 ... +120 Pa * -300 ... +300 Pa **	-100 Pa * / -250 Pa **
	HYST	0 ... 50 Pa	0 Pa
IN 1-T	VALUE TOP	-800 ... +800 °C	60 °C
	VALUE BOT	-800 ... +800 °C	5 °C
	HYST	0 ... 100 °C	0 °C
IN 1-P	VALUE TOP	-300 ... +300 Pa	+100 Pa * / +250 Pa **
	VALUE BOT	-300 ... +300 Pa	-100 Pa * / -250 Pa **
	HYST	0 ... 125 Pa	0 Pa
IN 2-H	VALUE TOP	0 ... 800 %rH	75 %rH
	VALUE BOT	0 ... 800 %rH	0 %rH
	HYST	0 ... 50 %rH	0 %rH
IN 2-P	VALUE TOP	-300 ... +300 Pa	+100 Pa * / +250 Pa **
	VALUE BOT	-300 ... +300 Pa	-100 Pa * / -250 Pa **
	HYST	0 ... 125 Pa	0 Pa

Table 15: Limits parameter description

* Value applies to a PUC 24 with an internal ±100 Pa sensor

** Value applies to a PUC 24 with an internal ±250 Pa sensor

5.4 Filter setting [FILTER]

In various applications, brief pressure surges or other undesirable short signal fluctuations may occur. For this case, the PUC 24 has a low-pass filter for smoothing the measured values (see Fig. 13). The filter time, which can be set, is dependent on the expected signal fluctuations and the desired degree of smoothing.

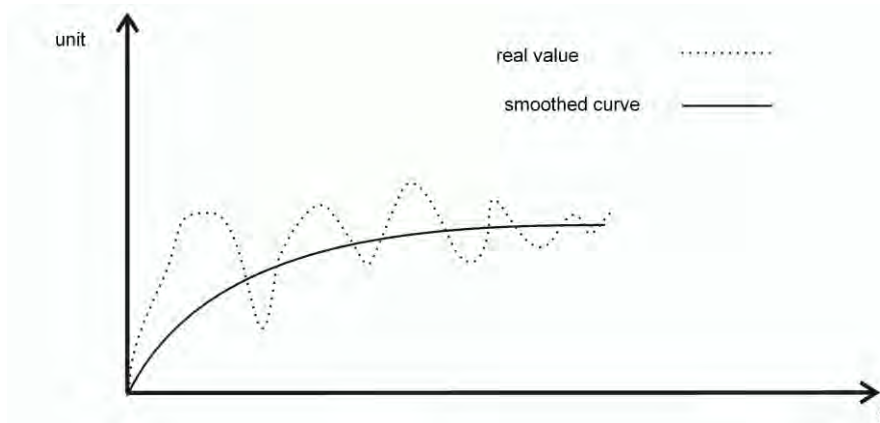

Fig. 13: Effect of the low-pass filter on the measured value display

Input / sensor	Range of values	Default setting
Internal pressure	0.025 ... 40 s	0.5 s
IN 1	0.125 ... 40 s	0.125 s
IN 2	0.125 ... 40 s	0.125 s

Table 16: Filter settings parameter description



The filter has the function of smoothing any fluctuating measured values. For the activation and deactivation delays of the relays, please use the corresponding possible settings (see section 5.5.2 entitled “Relay activation and deactivation delays”).

5.5 Relays [RELAY]

The PUC 24 has two relays (in some variants of the PUC 24 these relay contacts are not present). Relay 1 is triggered when the upper limits have been exceeded; relay 2 is triggered when values fall below the lower limits. In the quiescent state, contacts 3/4 and 6/7 are closed at the relay connector. If the signal drops below the limit, contacts 5/6 close and if the signal exceeds the limit, contacts 2/3 close.

5.5.1 Switching conditions and relay test [RELAY / COND. TEST]

In this menu item, you specify which measured values are included in controlling the relays (internal pressure, IN1 and IN2 input signal). This setting always applies to both the upper and the lower limits of the corresponding signal.

Parameters	Range of values				Default setting
Condition	Code	Internal pressure sensor	IN1	IN2	7 - All limits are included in the relay control system
	0				
	1			x	
	2		x		
	3		x	x	
	4	x			
	5	x		x	
	6	x	x		
	7	x	x	x	

Table 17: Switching conditions parameter description



While setting the switching conditions, both relays are energized for test purposes (until the final pressing of the Enter key).

5.5.2 Relay activation and deactivation delays [RELAY / TIME REL.]

A separate activation delay and deactivation delay can be set for each of the two relays. Please keep in mind that the activation delay of the relay is the same as the deactivation delay.

Parameter	Applies to	Range of values	Default setting
Time 1	Relay 1	0 ... 240 s	5 s
Time 2	Relay 2	0 ... 240 s	5 s

Table 18: Activation and deactivation delay parameter description

Example: With an activation and deactivation delay of 5 s, there are three possible alarm sequences shown in the following figure.

1. The duration of the alarm state is shorter than the activation and deactivation delay:

The acoustic alarm is triggered immediately once the limit is passed (alarm state). As the response delay is shorter than the duration of when the limit is passed, the corresponding relay does not switch. The acoustic alarm is switched off immediately when the alarm state no longer exists.

2. The duration of the alarm state is longer than the activation and deactivation delay and the alarm is not confirmed:

The acoustic alarm is triggered immediately once the limit is passed (alarm state). After the response delay of 5 s, the appropriate relay switches. Once the cause of the alarm is no longer present, the acoustic alarm is switched off immediately. The relay switches off after the deactivation delay of 5 s.

3. The duration of the alarm state is longer than the activation and deactivation delay but the alarm is confirmed:

The acoustic alarm is triggered immediately once the limit is passed (alarm state). After the response delay of 5 s, the appropriate relay switches. The acknowledgement deactivates the acoustic alarm and the relay immediately.

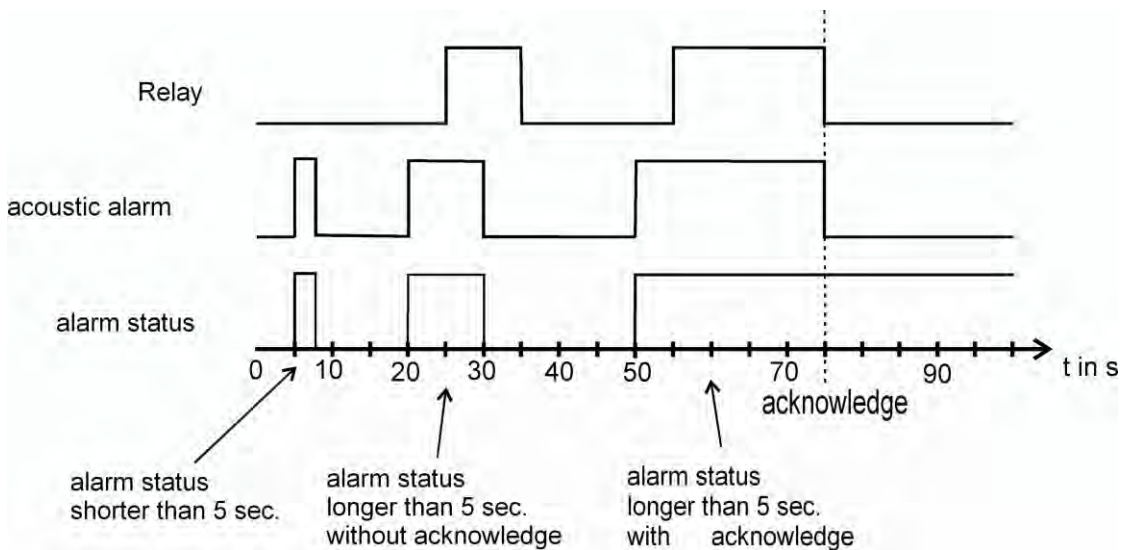

Fig. 14: The three possible alarm sequences with an activation and deactivation delay of 5 s



For using the functions described above, also keep in mind the switching conditions of the relays and the adjustable alarm confirmation described in this section.

5.5.3 Alarm acknowledgement [RELAY / ACKNOWLEDGE]

In the alarm state (exceeding the upper limits or dropping below the lower limits), relay 1 or relay 2 is activated. Under consideration of the activation and deactivation delays, the relays remain energized as long as the alarm state persists. If this behaviour is not desired (e.g., because a loud horn is connected to the relay outputs), the alarm acknowledgement can be activated.

If “Acknowledge” is activated, the alarm is confirmed by pressing one of the four keys. This not only switches off the internally generated acoustic alarm but also deactivates both relays. The alarm (acoustic alarm and relay activation) is triggered again if an additionally limit is passed or an existing passed limit is eliminated and triggered again.

Parameter	Range of values	Default setting
Acknowledge	ON OFF	OFF

Table 19: Relay acknowledgement parameter description

6 RS232 Interface

This section only applies to devices equipped with RS232 interface. The serial RS232C interface allows configuring the PUC 24 (alternatively to the configuration with the help of the integrated keys in the front plate) as well as reading the measured values and triggering certain actions (e.g. zero-point calibration) with the help of a PC.

The serial interface has the following settings:

- 9600 Baud
- 8 data bits
- 1 stop bit
- no parity

6.1 List of RS232 commands

For the configuration of the PUC 24 and the reading of measured values the following commands are available:

6.1.1 Commands for Configuration

All parameters can be written and read. For each parameter the command for read and write is the same, only the character ">" is placed before the command to write, while a "?" is placed before the command to read.

Both when writing and reading a parameter, the PUC 24 sends back the same parameter name with the actual value as answer:

Example for writing:

```
>WarnPdown -22.5  
WarnPdown -22.5
```

(The bottom warning value for the internal pressure is being set to -22.5Pa.)

Example for reading:

```
?WarnPdown  
WarnPdown -22.5
```

(The bottom warning value for the internal pressure is actually -22.5Pa.)

For sending parameter values the following rules apply:

- The spelling of the parameter names is case-sensitive.
- A blank has to be between parameter name and value.
- Positive values have to begin directly with a numeral, a "+" is not allowed.
- In case of decimal places, these have to follow a point (no comma!). Integers can be without a ".0", but it can be present optionally.
- Pressure values are always being sent in Pa, even if the display in the front plate shows the values in another unit.
- Sending a value has to be finished by a <CR> (ASCII character no. 13).

Under consideration of the same rules also the PUC 24 sends the answer telegrams.



A value which has been sent is effective immediately, but it is not saved permanently automatically. For this, the command “SaveSet” has to be used.



In case the PUC 24 doesn't accept the value which has been sent, the answer contains an error code (see section 6.2).

Now a listing of all commands for configuration:

No.	Name	Format	Unit	Description
1	ScalPdown	float	Pa	Scaling of int. pressure, bottom value (for analogue output)
2	ScalPup	float	Pa	Scaling of int. pressure, top value (for analogue output)
3	ScalIN1Tdown	float	°C	Scaling of IN1, bottom value (input IN1 as temperature)
4	ScalIN1Tup	float	°C	Scaling of IN1, top value (input IN1 as temperature)
5	ScalIN1Pdown	float	Pa	Scaling of IN1, bottom value (input IN1 as pressure)
6	ScalIN1Pup	float	Pa	Scaling of IN1, top value (input IN1 as pressure)
7	ScalIN2Hdown	float	%rH	Scaling of IN2, bottom value (input IN2 as humidity)
8	ScalIN2Hup	float	%rH	Scaling of IN2, top value (input IN2 as humidity)
9	ScalIN2Pdown	float	Pa	Scaling of IN2, bottom value (input IN2 as pressure)
10	ScalIN2Pup	float	Pa	Scaling of IN2, top value (input IN2 as pressure)
11	WarnPdown	float	Pa	Warning of int. pressure, bottom value
12	WarnPup	float	Pa	Warning of int. pressure, top value
13	WarnPHyst	float	Pa	Warning of int. pressure, hysteresis
14	WarnIN1Tdown	float	°C	Warning of IN1, bottom value (input IN1 as temperature)
15	WarnIN1Tup	float	°C	Warning of IN1, top value (input IN1 as temperature)
16	WarnIN1THyst	float	°C	Warning of IN1, hysteresis (input IN1 as temperature)
17	WarnIN1Pdown	float	Pa	Warning of IN1, bottom value (input IN1 as pressure)
18	WarnIN1Pup	float	Pa	Warning of IN1, top value (input IN1 as pressure)
19	WarnIN1PHyst	float	Pa	Warning of IN1, hysteresis (input IN1 as pressure)
20	WarnIN2Hdown	float	%rH	Warning of IN2, bottom value (input IN2 as humidity)
21	WarnIN2Hup	float	%rH	Warning of IN2, top value (input IN2 as humidity)
22	WarnIN2HHyst	float	%rH	Warning of IN2, hysteresis (input IN2 as humidity)
23	WarnIN2Pdown	float	Pa	Warning of IN2, bottom value (input IN2 as pressure)
24	WarnIN2Pup	float	Pa	Warning of IN2, top value (input IN2 as pressure)

No.	Name	Format	Unit	Description
25	WarnIN2PHyst	float	Pa	Warning of IN2, hysteresis (input IN2 as pressure)
26	FilterP	integer	msec	Filter time internal pressure
27	FilterIN1	integer	msec	Filter time IN1
28	FilterIN2	integer	msec	Filter time IN2
29	Lang	integer		Language 0 = german; 1 = english
30	Password	integer		Password (4-digit)
31	MeasRange	integer		measurement range 0 = ± 250 Pa; 1 = ± 100 Pa
32	ExtPress	integer		Configuration for external pressure 0 = no external pressure sensors 1 = only at IN-2 2 = only at IN-1 3 = at both analogue inputs
33	UnitP	integer		Display of internal pressure 0 = Pa; 1 = hPa; 2 = mbar; 3 = off
34	UnitIN1	integer		Display of IN-1 0 = $^{\circ}$ C or Pa; 1 = hPa; 2 = mbar; 3 = off
35	UnitIN2	integer		Display of IN-2 0 = %rH or Pa; 1 = hPa; 2 = mbar; 3 = off
36	SignalP	integer		Signal at analogue output 0 = 0 - 20mA; 1 = 4 - 20mA; 2 = 0 - 10V
37	SignalIN1	integer		Signal at IN-1 0 = 0 - 20mA; 1 = 4 - 20mA; 2 = 0 - 10V
38	SignalIN2	integer		Signal at IN-2 0 = 0 - 20mA; 1 = 4 - 20mA; 2 = 0 - 10V
39	Sound	integer		Warning sound 0 = off; 1 = on
40	SoundTime	integer	msec	Length of warning sound
41	DecPlP	integer		decimal places of internal pressure 0 = off; 1 = on
42	DecPlIN1T	integer		decimal places of IN1 as temperature 0 = off; 1 = on
43	DecPlIN1P	integer		decimal places of IN1 as pressure 0 = off; 1 = on
44	DecPlIN2H	integer		decimal places of IN2 as humidity 0 = off; 1 = on
45	DecPlIN2P	integer		decimal places of IN2 as pressure 0 = off; 1 = on
46	RelAssign	integer		Relay-Channel-Assignment 0 = never switched on 1 = when IN2 is exceeded/dropped 2 = when IN1 is exceeded/dropped 3 = when IN1 + IN2 is exceeded/dropped 4 = when int. pressure is exceeded/dropped 5 = when int. pressure + IN2 is exceeded/ dropped 6 = when int. pressure + IN1 is exceeded/ dropped 7 = when int. pressure + IN1 + IN2 is exceeded/ dropped

Nr.	Name	Format	Unit	Description
47	RelTime1	integer	sec	Response time for relay 1 (for exceedings)
48	RelTime2	integer	sec	Response time for relay 2 (for lower deviations)
49	RelAck	integer		Relay acknowledgement 0 = off; 1 = on
50	DeviceAdr	integer		Device address (only read access; is configured with BCD switches at the device)

6.1.2 Commands for reading the measured values and the status values

With the help of these commands the actual measured values as well as other status values can be read out. For the transfer of the messages, the same rules apply as for the commands for configuration.

Nr.	Name	Format	Einheit	Bedeutung
1	?IP	float	Pa/hPa/mbar	internal pressure ¹⁾
2	?IN1	float	°C/Pa/hPa/mbar	Signal at IN-1 ¹⁾
3	?IN2	float	%rH/Pa/hPa/mbar	Signal at IN-2 ¹⁾
4	?ST	byte		Status Bit 0 = 0 → Zero-point calibration is currently not in progress Bit 0 = 1 → Zero-point calibration is currently in progress ²⁾
5	?WARN	byte		Warning Status Bit 0: signal dropped below lower warning value of IN-2 or signal is below bottom measurement limit Bit 1: signal dropped below lower warning value of IN-1 or signal is below bottom measurement limit Bit 2: internal pressure dropped below lower warning value ³⁾ Bit 3: internal pressure is below bottom measurement limit Bit 4: signal exceeded upper warning value of IN-2 or signal is above upper measurement limit Bit 5: signal exceeded upper warning value of IN-1 or signal is above upper measurement limit Bit 6: internal pressure exceeded upper warning value ⁴⁾ Bit 7: internal pressure is above upper measurement limit

¹⁾ The transfer is carried out with the actually configured unit with the full internal accuracy. If the measured value is outside the measurement range, the answer contains an error code (see section 6.2).

²⁾ During a zero-point calibration the received measured values are not valid.

³⁾ Consider bit 3 additionally.

⁴⁾ Consider bit 7 additionally.

6.1.3 Other commands

Some actions can be activated directly with the help of certain commands. Here's a listing of these commands:

Nr.	Name	Format	Antwort	Bedeutung
1	RecallWE		PUC 24 Vx.x	Configuration according delivery state (the old measurement range keeps preserved) and reset PUC 24 ¹⁾
2	SaveSet		OK	Saving the actual configuration in EEPROM
3	MZ		OK	start zero-point calibration cycle (ZPCC) now
4	>CMD	byte	CMD <byte>	Control word Bit 0 = 0 → ZPCC automatically: Zero-point calibration is being started automatically by the PUC 24 every 15 min in the first hour following power-up and afterwards every hour Bit 0 = 1 → ZPCC is being started by an RS232 command (→ no automatic calibration) Bit 1 = 0 → Don't start ZPCC now Bit 1 = 1 → Start ZPCC now (The rising edge specifies the starting time, the bit has to be reset again during or after the ZPCC.)
5	?CMD		CMD <byte>	Reading of the control word
6	Reset		PUC 24 Vx.x	Reset the PUC 24 ¹⁾

¹⁾ After power-up as well as after a reset the PUC 24 comes up with the message "PUC 24 Vx.x", where x.x represents the actual software release. The time until this message appears might be up to 5 sec.

6.2 Error codes

After sending a command the following error messages are possible:

No.	Error message	Description
1	Err_CmdNotExist	An unknown command has been sent to the PUC 24.
2	Err_ValRange	The transfered parameter value is outside it's valid limits. This might happen also (among other things), if a top value is smaller or equal the associated bottom value.
3	Err_ChnlNotActive	It was tried to read a measured value of a channel which is currently switched off.
4	Err_Underflow	The measured value is below the bottom measurement limit.
5	Err_Overflow	The measured value is above the upper measurement limit.

6.3 Assignment of the RS232 connector

The assignment of the RS 232 connection corresponds to the assignment specified by the EIA (Electronic Industries Alliance):

9-pole D-SUB-jack (female)
(top view from outside):

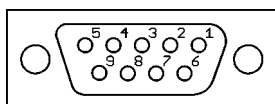

5-pole M12-jack (female, B-encoded)
(top view from outside):

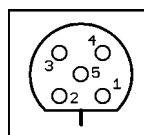

The RS232 interface of the PUC 24 is available in the following variants:

1) PUC 24 variants with 9-pole D-SUB-jack (female) directly integrated in the housing (only for wall thicknesses up to 5mm):

Pin No.	Signal	Description
2	TxD	Sending line
3	RxD	Receiving line
5	GND	Ground

2) PUC 24 variants with 9-pole D-SUB-jack (female) at a flying leads cable:

Pin No.	Signal	Description
2	TxD	Sending line
3	RxD	Receiving line
5	GND	Ground

3) PUC 24 variants with 5-pole M12-jack (female, B-encoded) at a flying leads cable:

Stift Nr.	Signal	Bedeutung
2	TxD	Sending line
3	GND	Ground
4	RxD	Receiving line

Table 20: Pin assignment of the RS232 connector

6.4 Interface configuration

Under Windows XP set up the serial interface configuration (COM port) as follows. The process is similar for older Windows systems.

To find the interface configuration: Go to START → SETTINGS → CONTROL PANEL. There click on SYSTEM and select the HARDWARE tab. Subsequent click on DEVICE MANAGER, there select PORTS. Now double-click on the COM port which is used, thereafter select the PORT SETTINGS tab.

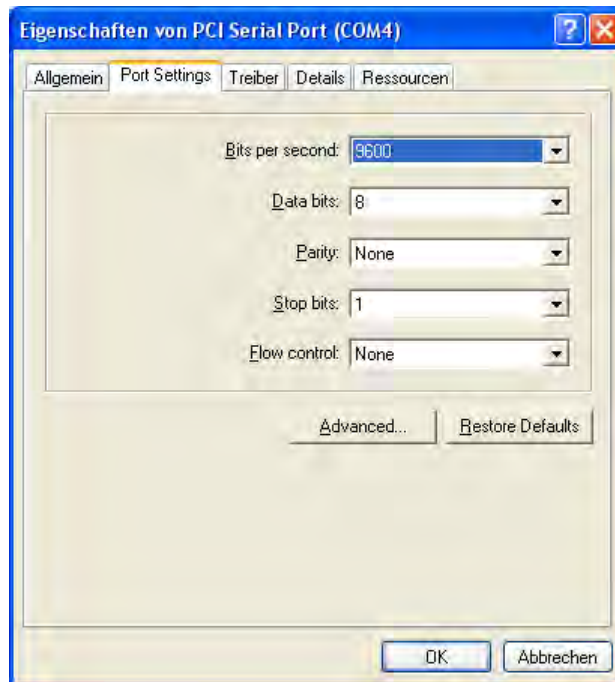

6.5 Configuration software

For a comfortable configuration and maintenance/logging of the measured values the PC software "PUC 24 Start-Up Tool" exists. The software is available for downloading from the Internet site www.halstrup-walcher.de under the path "Downloads / Software".

When a measurement is currently running, the program presents itself in the following way:

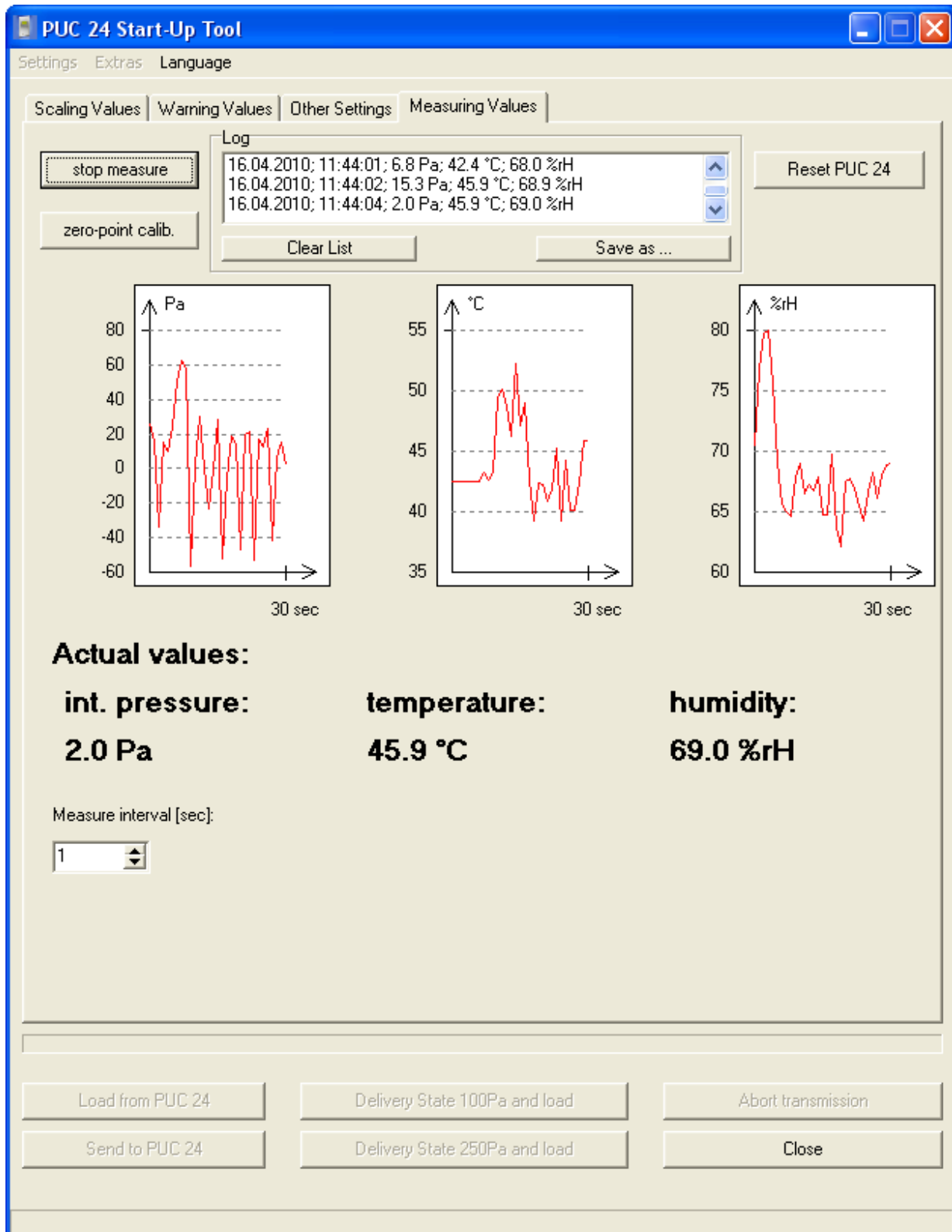

Short description of the program features:

Tab “Scaling Values”:

The scaling values for the analogue output of the internal pressure as well as for the both analogue inputs can be configured here.

Tab “Warning Values”:

The warning values for the internal pressure as well as for the both analogue inputs can be configured here.

The scaling and warning values of a pressure might be entered in different units (hPa, kPa, mbar, mmH₂O, mmHg, Psi, inH₂O, inHg). For this purpose, double-click on the corresponding input field. The following window appears:

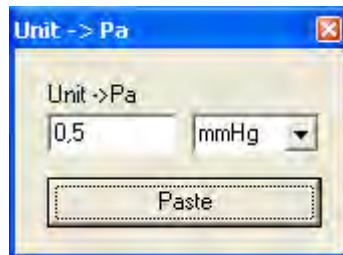

In this window enter the desired value in the desired unit and click “Paste”. The value will be internally calculated in Pa and entered as scaling or warning value.

Should the configuration be in Pa, click only one time into the corresp. input field (instead of double-click) and enter directly the value.

Tab “Other settings”:

All other settings can be configured here.

Tab “Measuring Values”:

Here all measured values are displayed graphically and in a list, besides there’s a possibility to save the values in a CSV-compatible file. Additionally a zero-point calibration and a reset can be activated directly.

Tab “Settings”:

The actual configuration parameters can be saved in a file (*.puc) respectively being loaded from there.

This is (among other things) helpful for the archival storage of configuration sets as well as for copying a configuration between 2 devices.

The “.puc” files use the Windows INI format, therefore the “.puc” files can be easily edited with external programs or with any common text editor.

Menu item “Extras → ComPort”:

Here the COM port which is used can be set. The other port settings must not be changed (9600 Baud, 8 data bits, 1 stop bit, no parity).

Menu item “Language”:

Here the language can be set which is used within the configuration software. This setting is independent of the language which is used inside the PUC 24 itself.



The settings for “ComPort” and “Language” are being saved in the file “PUC 24 ToolConfig.ini” after each change. When starting the software the next time, the settings of this file will be used.

Button “Load from PUC 24”:

All configuration parameters are being load and the fields in the tabs “Scaling Values”, “Warning Values” and “Other Settings” are being filled.

Button “Send to PUC 24”:

All configuration parameters of the tabs “Scaling Values”, “Warning Values” and “Other Settings” are being sent to the PUC 24 and there being saved in the EEPROM.

Button “Delivery State 100Pa and load”:

The measurement range $\pm 100\text{Pa}$ is being set, the PUC 24 configures itself according the delivery state for this measurement range and resets itself. Afterwards these configuration parameters are being load.

Button “Delivery State 250Pa and load”:

The measurement range $\pm 250\text{Pa}$ is being set, the PUC 24 configures itself according the delivery state for this measurement range and resets itself. Afterwards these configuration parameters are being load.

Button “Abort transmission”:

A loading or sending activity is being aborted ahead of time.

Button “Close”:

The program is being closed.

7 Profibus DP interface

This section only applies to devices equipped with Profibus DP interface. For configuring the PUC 24 as a slave in a Profibus system, the GSD files “HaWa09BF.GSD” (for PUC 24 with internal ± 100 Pa sensor) and “HaWa0BCD.GSD” (for PUC 24 with internal ± 250 Pa sensor) are supplied. As an alternative, the GSD files are available for downloading from the Internet site www.halstrup-walcher.de under the path “Downloads / Software”.

7.1 Profibus DP address

The slave address is configured using the two rotary “DP ADDRESS” switches on the back of the PUC 24. Each switch has 10 positions. The tens position of the address is set using the left switch, the units position using the right switch. Consequently, addresses between 00 and 99 can be used. After assigning a new address, the supply voltage of the PUC must be briefly interrupted (Reset), or choose “Reset” in the Menu [SETTINGS]. The currently valid address can be checked in the menu [BUS].

7.2 Terminating resistors

The device has bus terminating resistors that can be connected using the two DIP switches on the back of the PUC 24.

Both switches set to “ON”	- resistors connected
Both switches set to “OFF”	- resistors disconnected

7.3 Modules

There are nine modules available for configuring the PUC 24 as a Profibus slave (combining the input and output data). Any combination of modules is permitted. The only thing to keep in mind is that module 33 (“command byte”) must be a component of the configuration.

No.	Conf.	Description																			
1	0xD0	1 word input; consistent over the entire length; signed int “Measured value, internal pressure” (in 1/10 Pa)																			
2	0xD0	1 word input; consistent over the entire length; signed int “Measured value, temp/pressure IN-1” (in 1/10°C or 1/10 Pa)																			
3	0xD0	1 word input; consistent over the entire length; signed int “Measured value, humidity/pressure IN-2” (in 1/10%rH or 1/10 Pa)																			
4	0x10	1 byte input; consistent over byte/word “Warning States” <table border="1" style="margin-left: 20px;"> <thead> <tr> <th>Bit</th> <th colspan="2">Description</th> </tr> </thead> <tbody> <tr> <td>0</td> <td rowspan="4">Value lower than the low limit</td> <td>IN 2</td> </tr> <tr> <td>1</td> <td>IN 1</td> </tr> <tr> <td>2</td> <td rowspan="2">Internal pressure (if at least one bit =1)</td> </tr> <tr> <td>3</td> </tr> <tr> <td>4</td> <td rowspan="4">Upper limit exceeded</td> <td>IN 2</td> </tr> <tr> <td>5</td> <td>IN 1</td> </tr> <tr> <td>6</td> <td rowspan="2">Internal pressure (if at least one bit =1)</td> </tr> <tr> <td>7</td> </tr> </tbody> </table> <p>Bit = 1 → outside the limits Bit = 0 → within the limits</p> <p>If a measured value is outside the limits, it may also be outside the valid measurement range. The transferred value could therefore be invalid.</p>	Bit	Description		0	Value lower than the low limit	IN 2	1	IN 1	2	Internal pressure (if at least one bit =1)	3	4	Upper limit exceeded	IN 2	5	IN 1	6	Internal pressure (if at least one bit =1)	7
Bit	Description																				
0	Value lower than the low limit	IN 2																			
1		IN 1																			
2		Internal pressure (if at least one bit =1)																			
3																					
4	Upper limit exceeded	IN 2																			
5		IN 1																			
6		Internal pressure (if at least one bit =1)																			
7																					
5	0x10	1 byte input; consistent over byte/word “Status” <table border="1" style="margin-left: 20px;"> <thead> <tr> <th>Bit</th> <th>Description</th> </tr> </thead> <tbody> <tr> <td>0</td> <td>Zero-point calibration cycle (ZPCC)</td> </tr> <tr> <td>1</td> <td rowspan="7">No Meaning</td> </tr> <tr> <td>2</td> </tr> <tr> <td>3</td> </tr> <tr> <td>4</td> </tr> <tr> <td>5</td> </tr> <tr> <td>6</td> </tr> <tr> <td>7</td> </tr> </tbody> </table> <p>Byte.0 = 0 → ZPCC is not being performed at this time Byte.0 = 1 → ZPCC is being performed at this time (→ the measured value supplied are invalid)</p>	Bit	Description	0	Zero-point calibration cycle (ZPCC)	1	No Meaning	2	3	4	5	6	7							
Bit	Description																				
0	Zero-point calibration cycle (ZPCC)																				
1	No Meaning																				
2																					
3																					
4																					
5																					
6																					
7																					

33	0x10	1 byte output; consistent over byte/word "Control word"	<table border="1"> <thead> <tr> <th>Bit</th> <th>Description</th> </tr> </thead> <tbody> <tr> <td>0</td> <td>ZPCC by the DP master</td> </tr> <tr> <td>1</td> <td>Start ZPCC now</td> </tr> <tr> <td>2</td> <td rowspan="6">No meaning</td> </tr> <tr> <td>3</td> </tr> <tr> <td>4</td> </tr> <tr> <td>5</td> </tr> <tr> <td>6</td> </tr> <tr> <td>7</td> </tr> </tbody> </table>	Bit	Description	0	ZPCC by the DP master	1	Start ZPCC now	2	No meaning	3	4	5	6	7
			Bit	Description												
0	ZPCC by the DP master															
1	Start ZPCC now															
2	No meaning															
3																
4																
5																
6																
7																
<p>Byte.0 = 0 → ZPCC automatically: Zero-point calibration is being started automatically by the PUC 24 every 15 min in the first hour following power-up and afterwards every hour</p> <p>Byte.0 = 1 → ZPCC is started by the Profibus master (→no automatic calibration)</p> <p>Byte.1 = 0 → Don't start ZPCC now</p> <p>Byte.1 = 1 → Start ZPCC now (The rising edge specifies the starting time, the bit has to be reset again during or after the ZPCC.)</p>																
34	0xE0	1 word output; consistent over the entire length; signed int "Set pressure, line 1" (in 1/10 Pa)														
35	0xE0	1 word output; consistent over the entire length; signed int "Set temperature/pressure, line 2" (in 1/10°C or 1/10 Pa)														
36	0xE0	1 word output; consistent over the entire length; signed int "Set humidity /pressure, line 3" (in 1/10%rH or 1/10 Pa)														

Table 21: Configurable slave modules of the PUC 24

7.4 Setting the parameters of the PUC 24 as a Profibus slave

The following parameters of the PUC 24 Profibus slave are sent automatically to the PUC after the Profibus connection has been established by the master. No menu settings are necessary for this. After the Profibus connection has ended, the device returns automatically to the state of a pure measurement device. However, the Profibus parameters are stored in the device.

Parameter	Description
Sound (ein/aus)	Activate or deactivate the acoustic signalling device
Relay assignment	see section 5.5.1 entitled "Switching conditions and relay test [RELAY / COND. TEST]"
Time for relay x (sec.)	Response time for the relay in seconds
Measurement range	100Pa or 250Pa; see section 5.2.3 entitled "Measurement range of the internal pressure sensor [SETTINGS / MEAS. RANGE]"
Relay acknowledgement	Switch relay acknowledgement on or off
Voltage or current	Select between voltage (0-10 V) or current (0-20 mA, 4-20 mA) for the analogue channels
External pressure	External pressure at the IN ports
Display	Specify the pressure units and whether to blank the individual lines or not
Language	Select the language (D or GB)
Decimal places	Activate or deactivate
Sound length (in 50 msec)	Set the pulse duration and separation of the acoustic signalling device (n x 50 msec) (Ex. "40" → 2 seconds)
Scaling (upper) ...	Set the upper scale value (each with a factor of 10) Example for IN2 (humidity) ([1/10]%rH): "1000" → 100.0 %rH
Scaling (lower) ...	Set the lower scale value (each with a factor of 10) Example for IN2 (humidity) ([1/10]%rH): "10" → 1.0 %rH
Warning (upper) ...	Set the upper limit (each with a factor of 10) Example for internal pressure ([1/10]Pa): "1000" → 100.0 Pa
Warning (lower) ...	Set the lower limit (each with a factor of 10) Example for internal pressure ([1/10]Pa): "-1000" → -100.0 Pa
Hyst. ...	Set hysteresis (each with a factor of 10) Example for IN1 (temperature) ([1/10]°C): "100" → 10.0 °C
Filter duration (x) (msec)	Filter time in msec, see section 5.4 entitled "Filter setting"

Table 22: Parameters of the slave PUC 24

7.5 Assignment of the Profibus connector

The assignment of the Profibus DP connection corresponds to the assignment specified by the PNO (Profibus User Organization):

9-pole D-SUB-jack (female)
(top view from outside):

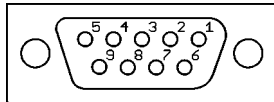

5-pole M12-jack (female, B-encoded)
(top view from outside):

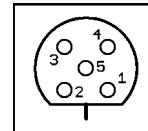

The Profibus DP interface of the PUC 24 is available in the following variants:

1) PUC 24 variants with 9-pole D-SUB-jack (female) directly integrated in the housing (only for wall thicknesses up to 5mm):

Pin No.	Signal	Description
3	RxD/TxD-P	Receive/transmit data, positive, B line
4	CNTR-P	Repeater control signal (flow control); RTS signal
5	DGND	DGND (reference potential to VP)
6	VP	Positive supply voltage (P5V)
8	RxD/TxD-N	Receive/transmit data, negative, A line
Housing	Shield	Shield or protective ground

2) PUC 24 variants with 9-pole D-SUB-jack (female) at a flying leads cable:

Pin No.	Signal	Description
3	RxD/TxD-P	Receive/transmit data, positive, B line
8	RxD/TxD-N	Receive/transmit data, negative, A line
Housing	Shield	Shield or protective ground

3) PUC 24 variants with 5-pole M12-jack (female, B-encoded) at a flying leads cable:

Pin No.	Signal	Description
2	RxD/TxD-N	Receive/transmit data, negative, A line
4	RxD/TxD-P	Receive/transmit data, positive, B line
Thread	Shield	Shield or protective ground

Table 23: Pin assignment of the Profibus connector



In the PUC 24 variants with a flying leads cable an original Profibus DP cable is used. Therefore it arises that for these variants the connection of an external terminating resistor is NOT possible (that is: for bus termination the internal terminating resistor has to be used).

8 Adjusting the PUC 24 [TEACH]

Depending on the conditions for using the PUC 24, it may be necessary to adjust the internal pressure transmitter and the analogue inputs and outputs (IN1, IN2 and OUT-P).



When adjusting the pressure sensor and the inputs and outputs, the characteristic curves are affected and the default settings changed. These functions are to be performed with special care. For this reason, this submenu is secured with an additional code.

8.1 Adjusting the internal pressure transmitter

After selecting the “TEACH” submenu, the request to enter the code appears (“CODE - TEACH”). Please proceed as follows:

1. Press the “Scroll right” key - an “X” appears
2. Confirm using “Enter” and “Scroll up” until “Internal pressure” is activated
3. Press “Enter” - the target pressure to be applied to the pressure ports of the PUC 24 appears in the display
4. After applying the target value, confirm using Enter - after a few seconds, the next target value appears
5. Continue to repeat this process until no more target values appear
6. Exit the menu using the “Menu” key and briefly interrupt the voltage (hardware reset) or choose “Reset” in the Menu [SETTINGS]



If, during this process, an “X” or a “0” appears, a selection can be made using the “Scroll up” key:

- X - continue the process (adjust more values)
- 0 - end adjustment

Confirm your selection using the “Enter” key.

8.2 Adjusting the analogue inputs and outputs

After selecting the “TEACH” submenu, the request to enter the code appears (“CODE - TEACH”). Please proceed as follows:

1. Press the “Scroll right” key - an “X” appears
2. Confirm using “Enter” and “Scroll up” until “SIGNAL” is activated
3. Using the “Scroll right” key, select between the current (“I”) and voltage input (“V”) and confirm using “Enter”
4. Use “Scroll up” to select the input or output (“OUT-P”, “IN1” or “IN2”) and confirm using “Enter”

If “IN1” or “IN2” has been selected:

5. Apply the target value (current or voltage) shown on the display to the input
6. Confirm using the “Enter” key and continue with 5

If “OUT-P” has been selected:

5. Using the “Scroll up” and “Scroll right” keys, continue to change the value in the center line until the current or voltage target value specified in the top line appears at the output terminals. The 4-digit value in the center of the display must be selected to be as large as possible while maintaining the target value. That is, it has to be found the highest possible 4-digit value for that the desired current or voltage target value appears at the output terminals (when teaching 0 V and 0 mA, there’s an interval between 0 and a value, from which the output signal begins to rise up).
6. Confirm using the “Enter” key and continue with 5

7. Continue to repeat this process until no more target values appear
8. Exit the menu using the “Menu” key and briefly interrupt the voltage (hardware reset) or choose “Reset” in the Menu [SETTINGS]

9 Care instructions for PUC 24

To clean the PUC24 surface please only use mild dishwashing detergent.

Don’t use any abrasive or acidly detergent, because the surface can be damaged.
Don’t use any detergent containing isopropanol, because the Display-Window will be cloudy.

10 Technical data

Measurement data	
measurement range	-100 to +100 Pa or -250 to +250 Pa
accuracy	0.5 % of the measurement range + 0.3 Pa
resolution	0.1 Pa
amplitude drift per temperature	0.03 %/K (+10 °C...+50 °C)
overload capability	200-times
Ambient conditions	
medium	air, all non-aggressive gases
operating temperature	+10 °C to +50 °C
storage temperature	-10 °C to +70 °C
conformity	 Declaration of conformity available upon request
Electrical data	
power consumption	8 VA
supply voltage	24 VDC (± 10 %)
electrical connections	PTR: STLZ1550/14-3.81H (signal) PTR: STLZ950/7-5.08H (relay) Binder: 79-4450-20-05 (Profibus DP)
output signal	0 ... +10 V ($R_L \geq 2 \text{ k}\Omega$) or 0 ... 20 mA ($R_L \leq 500 \Omega$) or 4 ... 20 mA ($R_L \leq 500 \Omega$)
input signals (2x)	0 ... +10 V ($R_i = 470 \text{ k}\Omega$) or 0 ... 20 mA ($R_i = 51 \Omega$) or 4 ... 20 mA ($R_i = 51 \Omega$)
Relays	
2 x changeover contacts (optionally not present)	6 A / 230 VAC each

Table 24: Technical data



Operating the PUC 24 at room temperature (20°C) ensures the highest possible level of accuracy for pressure measurements.

11 Troubleshooting

Problem	Cause	Corrective action
Display shows nothing	No power	Check the terminal connections and supply voltage
Pressure drops continuously	Leak	Firmly slide tubing completely onto ports; adjust diameter
No Profibus communication	No cable connection	Firmly seat connector; check terminating resistor
Intermittent acoustic signal	Alarm triggered	Confirm using any key

Table 25: Troubleshooting

12 Dimension drawing

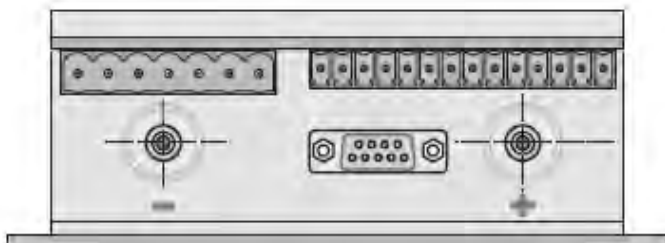
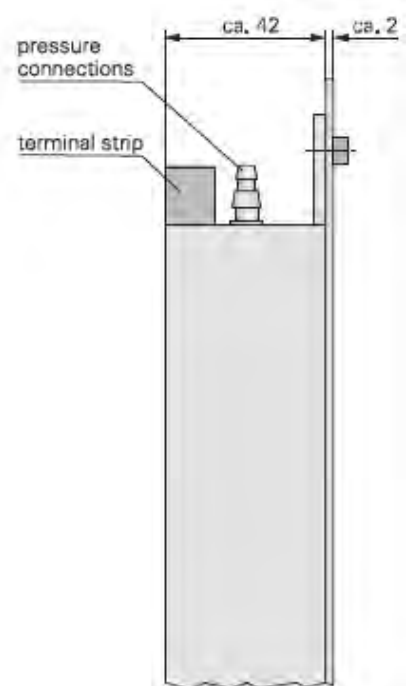
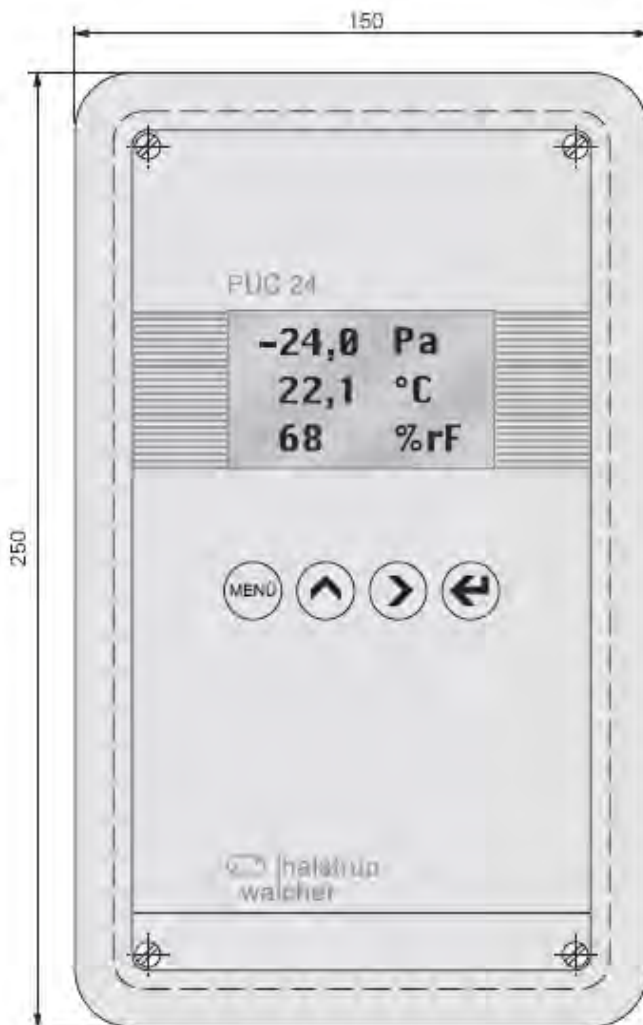

13 Menu tree

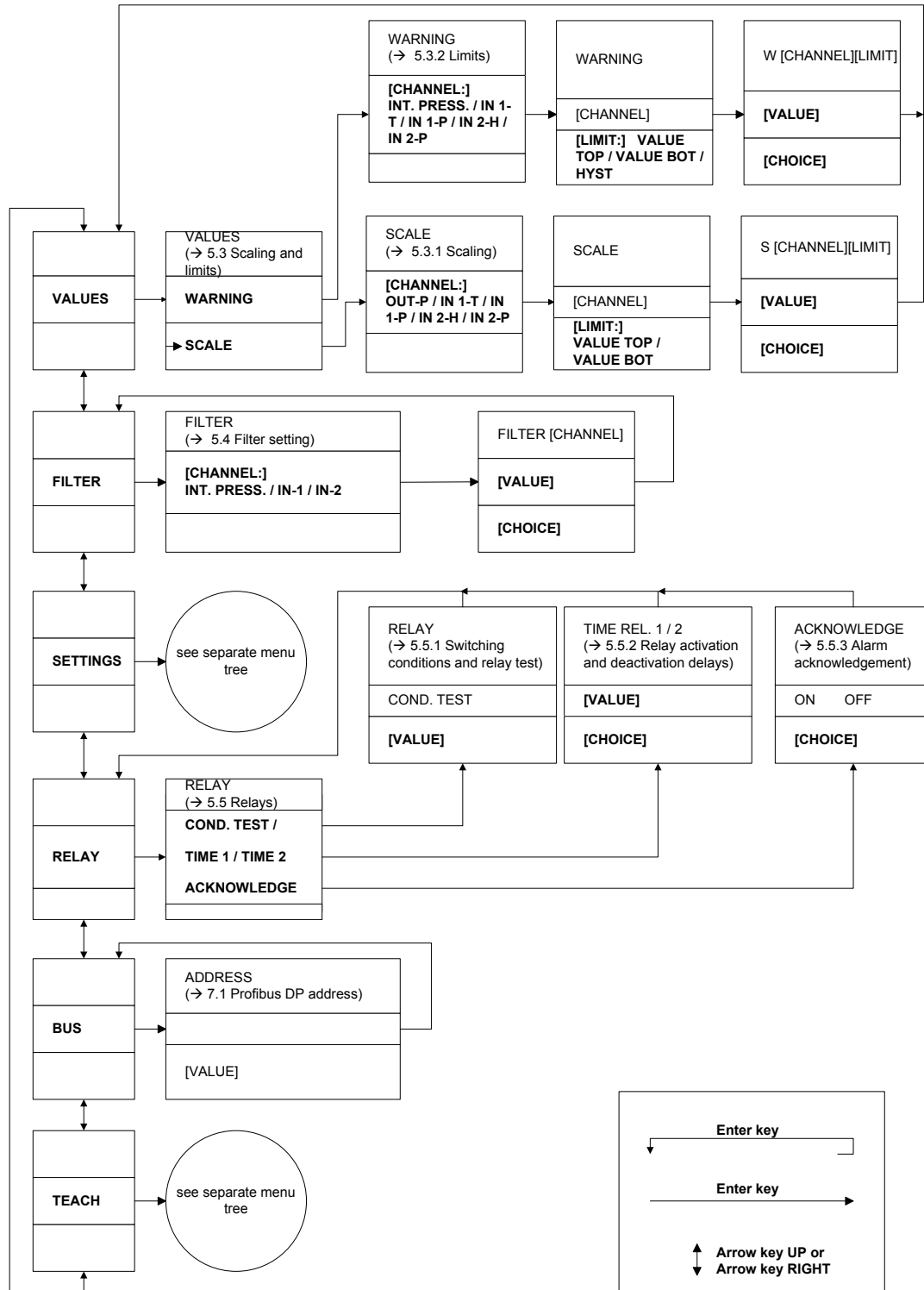

Fig. 15: Main menu

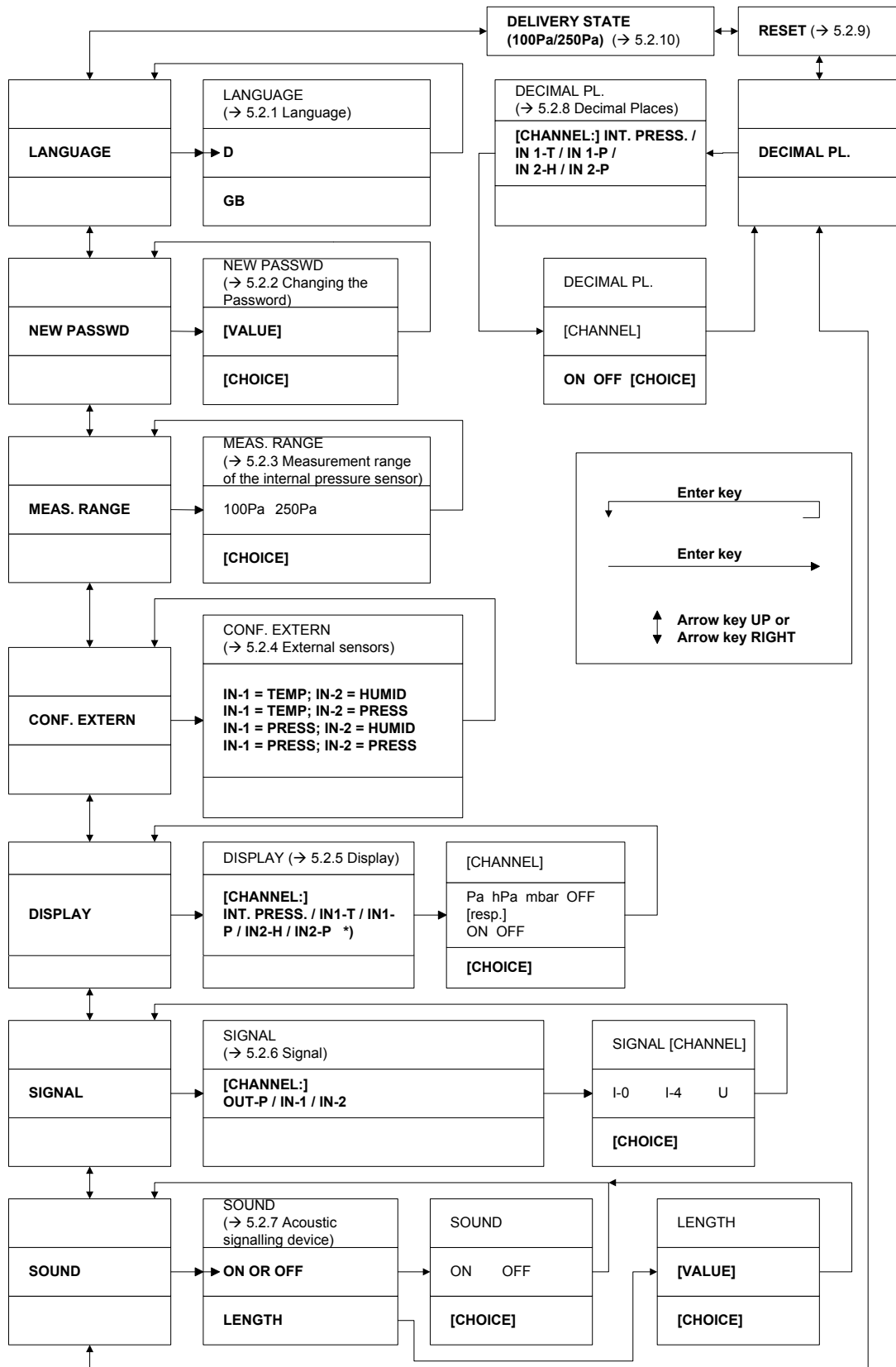

Fig. 16: "Settings" menu

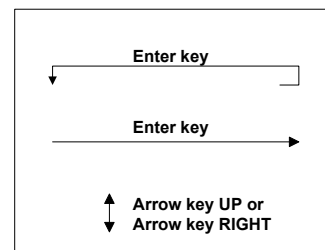
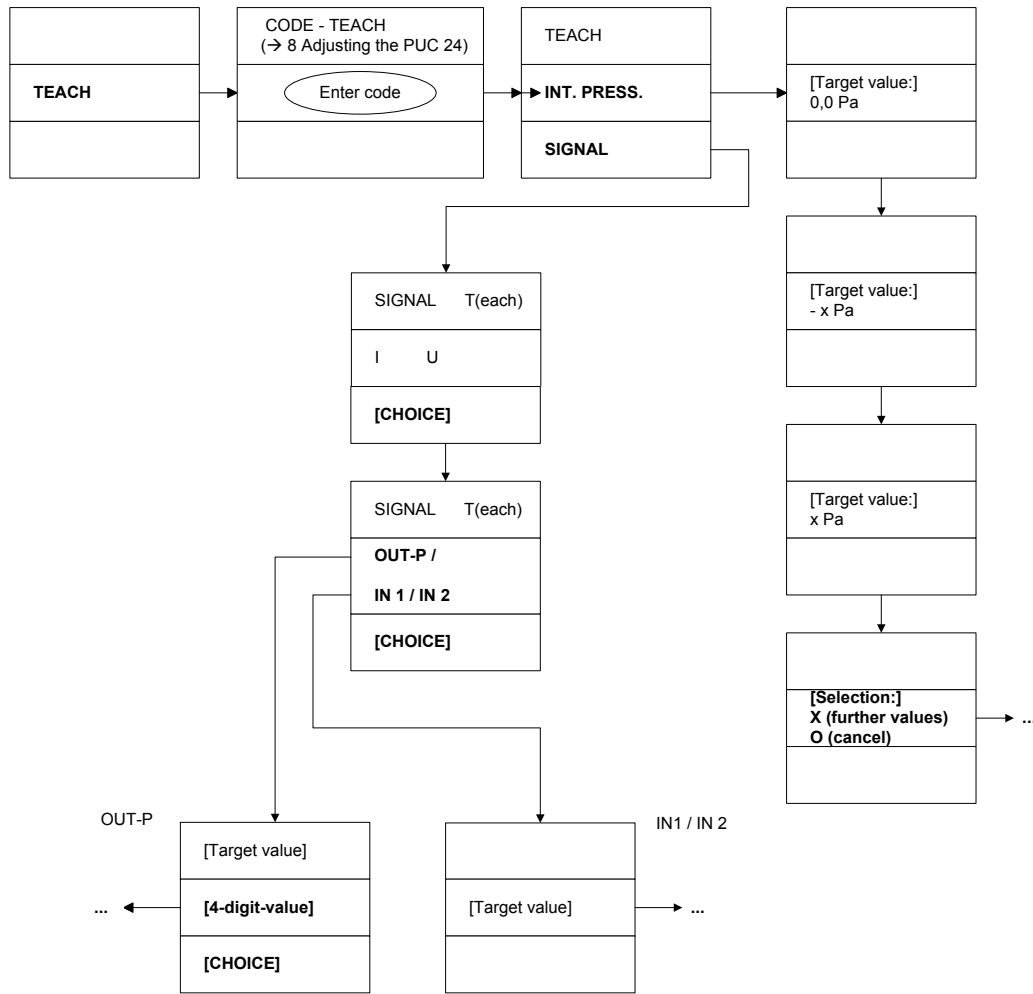

Fig. 17: "TEACH" menu

14 Ranges of values and default settings

The following table shows the minimum and maximum values of each range of values and the default settings:

Name	Minimum	Maximum	Default setting	Units
VALUES → SCALING				
OUT-P, lower	-120 / -300 *)	+120 / +300 *)	-100 / -250 *)	Pa
OUT-P, upper	-120 / -300 *)	+120 / +300 *)	100 / 250 *)	Pa
IN 1-T, lower	-800	+800	5	°C
IN 1-T, upper	-800	+800	60	°C
IN 1-P, lower	-300	+300	-100 / -250 *)	Pa
IN 1-P, upper	-300	+300	100 / 250 *)	Pa
IN 2-H, lower	0	800	0	%rH
IN 2-H, upper	0	800	75	%rH
IN 2-P, lower	-300	+300	-100 / -250 *)	Pa
IN 2-P, upper	-300	+300	100 / 250 *)	Pa
VALUES → WARNING				
Internal pressure, lower	-120 / -300 *)	+120 / +300 *)	-100 / -250 *)	Pa
Internal pressure, upper	-120 / -300 *)	+120 / +300 *)	100 / 250 *)	Pa
Internal pressure, Hyst.	0	50 / 125 *)	0	Pa
IN 1-T, lower	-800	+800	5	°C
IN 1-T, upper	-800	+800	60	°C
IN 1-T, Hyst.	0	100	0	°C
IN 1-P, lower	-300	+300	-100 / -250 *)	Pa
IN 1-P, upper	-300	+300	100 / 250 *)	Pa
IN 1-P, Hyst.	0	125	0	Pa
IN 2-H, lower	0	800	0	%rH
IN 2-H, upper	0	800	75	%rH
IN 2-H, Hyst.	0	50	0	%rH
IN 2-P, lower	-300	+300	-100 / -250 *)	Pa
IN 2-P, upper	-300	+300	100 / 250 *)	Pa
IN 2-P, Hyst.	0	125	0	Pa
FILTER				
Internal pressure	0.025	40	0.5	sec
IN-1	0.125	40	0.125	sec
IN-2	0.125	40	0.125	sec
LANGUAGE				
Language	D / GB		D	
NEW PASSWORD				
Password	0000	9999	0000	

Table 26: Range of values, Part 1

* The first value applies for the ±100 Pa version, the second value for the ±250 Pa version.

Name	Minimum	Maximum	Default setting	Units
MEASUREMENT RANGE				
Measurement range	±100 / ±250*		±100 / ±250*	Pa
EXTERNAL PRESSURE SENSORS				
External pressure sensors	None / on IN-1 / on IN-2 / on IN-1 and on IN-2		None	
DISPLAY				
Internal pressure	Pa / hPa / mbar / off		Pa	
IN-1	Pa / hPa / mbar / °C / off		°C	
IN-2	Pa / hPa / mbar / %rH / off		%rH	
VOLTAGE AND CURRENT SETTINGS				
OUT-P	0-10 V / 0-20 mA / 4-20 mA		4-20 mA	
IN-1	0-10 V / 0-20 mA / 4-20 mA		4-20 mA	
IN-2	0-10 V / 0-20 mA / 4-20 mA		4-20 mA	
SOUND				
On or off	On / off		Off	
Length	0.1	5.0	2.0	sec
DECIMAL PLACES				
Internal pressure	On / off		On	
IN 1-T	On / off		On	
IN 1-P	On / off		On	
IN 2-H	On / off		On	
IN 2-P	On / off		On	
RELAYS				
Relay/channel assignment	0	7	7	
Response time	0	240	5	sec
Acknowledge	On / off		Off	
Profibus DP address				
Address	0	99	11	

Table 27: Range of values, Part 2

* The first value applies for the ±100 Pa version, the second value for the ±250 Pa version.