

SATRON VG Flush Mount Pressure Transmitter

BPLV700
M2, revision 3
01.01.2014

SATRON VG pressure transmitter belongs to the series V transmitters which will have both analog and smart properties. SATRON VG is used for 0-1.4 kPa...0-25 MPa ranges. It is a 2-wire transmitter with HART® standard communication.

In pressure measuring applications SATRON VG transmitters are used for measuring the pressure of clean, sedimenting, crystallizing and sticking materials. The transmitter's sensor is piezoresistive. The rangeability is 100:1 for types VG6 - VG7.



TECHNICAL SPECIFICATIONS

Measuring range and span

See Selection Chart.

Zero and Span adjustment

Zero elevation: Calibrated span is freely selectable on the specified range depending from the desired option. This can be made by using external control shafts, keyboard (display option) or HART®/275/375 communicator.

Damping

- Time constant is continuously adjustable 0.01 to 60 s.

Temperature limits

Ambient: -30 to +80 °C
Process: -30 to +125 °C
0 to +200 °C (temp. code H)
Shipping and storage: -40 to +80 °C.
Operating temperature of display: 0 to +50°C (does not affect operation of the transmitter)

Pressure limits Min. and max. process pressure: See the appended tables.

Volumetric displacement

< 0.5 mm³/max. span
Output 2-wire (2W), 4-20 mA, user selectable for linear, square root, inverted signal or the transfer function (16 points) specified by the user

Supply voltage and permissible load

See the load capacity diagram;
4-20 mA output: 12 - 35 VDC.

Humidity limits

0-100 % RH; freezing of condensed water is not allowed in reference pressure channels.

PERFORMANCE SPECIFICATIONS

Tested in accordance with IEC60770: Reference conditions, specified span, no range elevation, horizontal mounting; O-ring seals, AISI316L diaphragm, silicone oil fill.

Accuracy

±0.05 % of calibrated span (span 1:1-5:1 /max.range).
On the measuring ranges 5:1-100 :1:
 $\pm[0.025+0.01 \times (\frac{\text{max. span}}{\text{calibrated span}})]\%$ of calibrated span
(incl. nonlinearity, hysteresis and repeatability)

Long-term stability

±0.1 % / max. span / 1 year

Temperature effect

- on -20 to +80 °C range (process temperature code N)
Zero and span error: ±0.15 % of max. span.
- on 0 to +200 °C range (process temperature code H)
Zero and span error: ±1 % of max. span, VG6 - VG8
±2 % of max. span, VG4 - VG5

Mounting position effect

Zero error < 0.32 kPa, which can be calibrated out.

Vibration effect (IEC 68-2-6: FC):

±0.1 % of measuring range/
2g/10 to 2000 Hz
4g/10 to 100 Hz

Power supply effect

< ±0.01 of calibrated span per volt

Insulation test voltage

500 V rms 50 Hz

CONSTRUCTION AND CALIBRATION

Materials

Diaphragm ¹⁾: AISI316L (EN 1.4435), Duplex (EN 1.4462), Hast. 276 (EN 2.4819), CoNi-alloy, Titanium Gr2 (EN 3.7035) or Tantalum.

Coupling ¹⁾: AISI316L (EN 1.4404), Duplex (EN 1.4462), Hast.C276 (EN 2.4819) or Titanium Gr2 (EN 3.7035).

Other sensing element materials: AISI316, SIS2343.

Filling fluid: Silicone oil, food industry oil or inert oil

Enclosure class IP66

¹⁾ Parts in contact with process medium

Housing with PLUG connector,

housing type codes H and T
Housing: AISI303/316
Seals: Viton® and NBR
TEST jacks: MS358Sn/PVDF, protected with silicone rubber shield.
PLUG connector: PA6-GF30 jacket, Silicone rubber seal, AISI316 retaining screw.

Housing with junction box/terminal strip,

housing type codes M and N
Housing: AISI303/316; Seals: Nitrile and Viton®; Nameplates: Polyester

Connection hose between sensing element and housing

Codes L and K:
PTFE hose with AISI316 braiding.

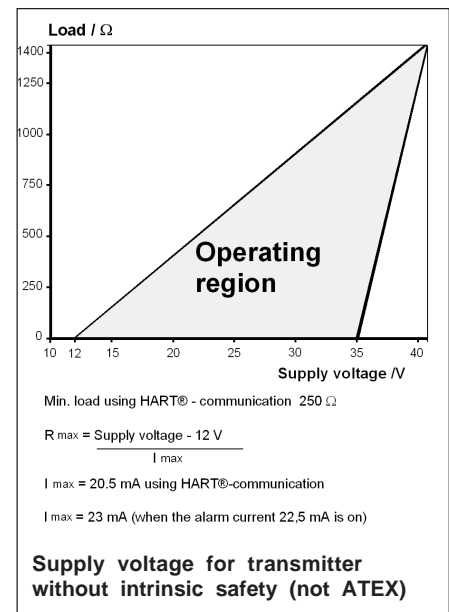

Pressure limits

Maximum process pressure, MPa

Transmitter type	Max. overload pressure	Pressure class
VG3	0.2	PN40
VG4	0.3	PN40
VG5	1.5	PN40
VG6	7.5	PN100
VG7	40.0	PN250
VG8	100.0	PN250

Minimum process pressure

T _{proc.} °C	Minimum pressure for different fill fluids (kPa, abs.)	
	DC200 100 cSt	Inert oil
20	5	8
40	8	10
80	16	28
120	21	53

SATRON VG Flush Mount Pressure Transmitter

Calibration

For customer-specified range with 1 s. damping. (If range is not specified, transmitter is calibrated for maximum range.)

Electrical connections

Housing with PLUG connector, **H** and **T**:
PLUG connector, connector type DIN 43650 model AF; Pg9 gland for cable; wire cross-section 0.5 to 1.5 mm².

Housing with junction box/terminal strip, **M** and **N**:
M20x1.5, 1/2-NPT inlet; screw terminals for 0.5 to 2.5 mm² wires

Process connections

G1 connecting thread
Process couplings: See Selection Chart and installation instructions or technical specification: Couplings for Transmitters **G150**.

Weight

Transmitter
- with housing type **H** and **T**: 0.7 kg
- with housing type **M** ja **N**: 1.2 kg

Product Certifications

European Directive Information

Electro Magnetic Compatibility (EMC directive 2004/108/EC)

All pressure transmitters

Atex Directive (94/9/EC)

Satron Instruments Inc. complies with the ATEX Directive.

European Pressure Equipment Directive (PED) (97/23/EC)

All Pressure Transmitters :
- Sound Engineering Practice

Hazardous Locations Certifications

European Certifications

ATEX Intrinsic Safety

Certification No. : DNV-2007-OSL-ATEX- 1346X

 II 1 GD T135°C EEx ia II C T4 -20°C ≤ Tamb ≤ 50°C

 II 2 GD T135°C EEx ia II C T4 -20°C ≤ Tamb ≤ 50°C

Input Parameters :

$U_i = 28 \text{ V}$
 $I_i = 93 \text{ mA}$
 $P_i = 0.651 \text{ W}$
 $C_i = 5 \text{ nF}$
 $L_j = 0.2 \text{ mH}$

Special Conditions for Safe Use (X) :

The enclosure with plastic window and the plastic DIN43650 connector must not be installed in potentially explosive atmosphere requiring category 1 apparatus. The non-conducting surface of the sensor element may be charged by the flow of non-conducting media, so there may be electrostatic hazard with IIC-gases. These units should be marked 2 GD.

The equipment shall be installed and connected according to the manufacturers instructions.

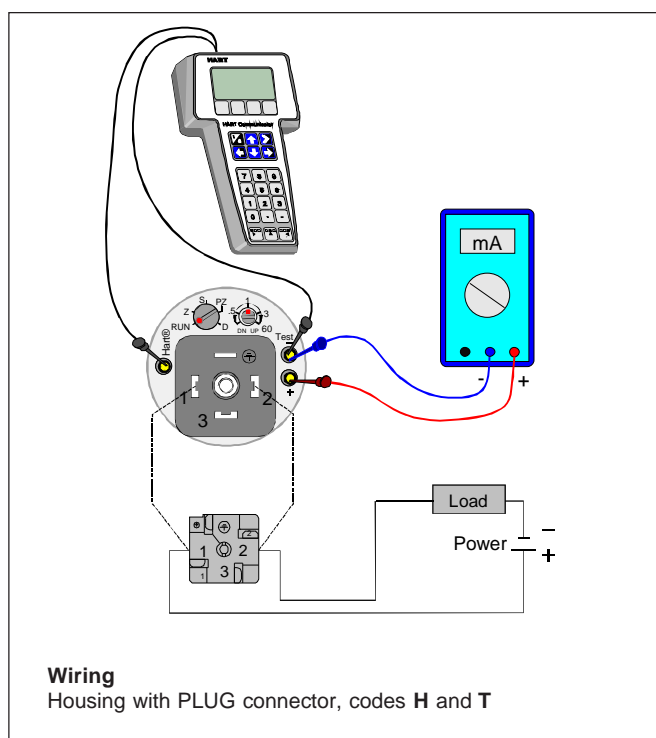
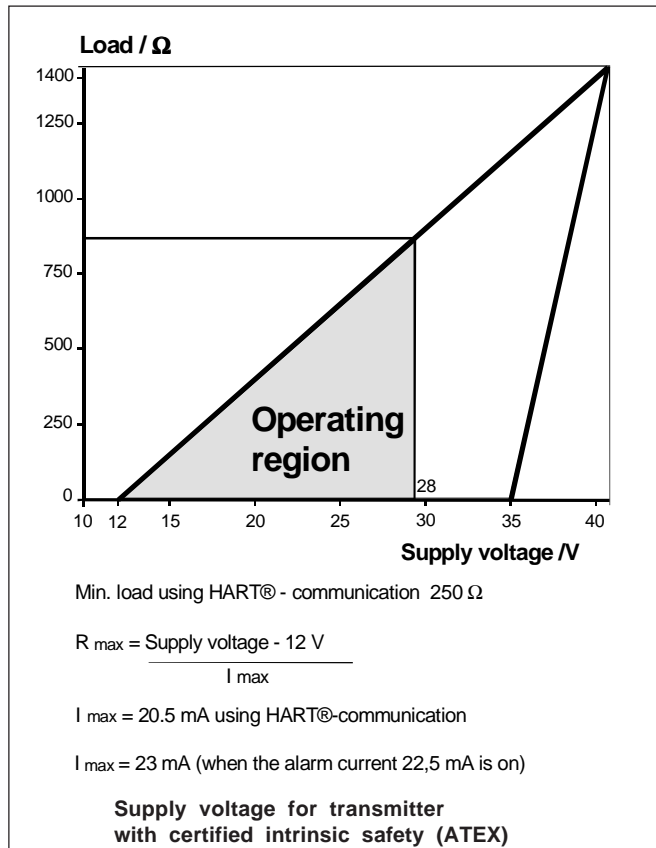

SATRON VG Flush Mount Pressure Transmitter

BPLV700

01.01.2014

Dimensions (in mm)

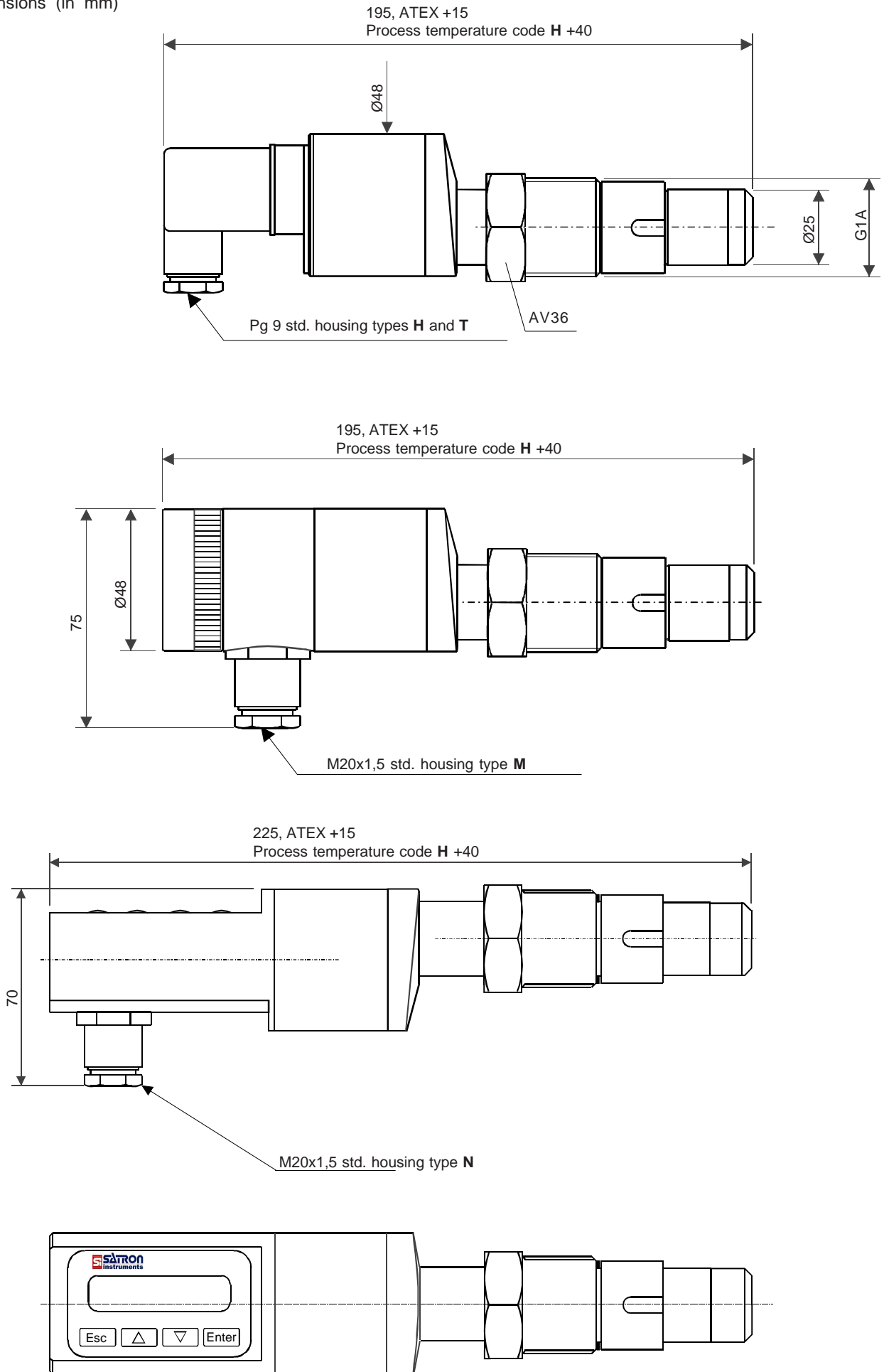

1300354100

SATRON VG Flush Mount Pressure Transmitter

BPLV700

01.01.2014

1300354100

Dimensions (in mm)

225, ATEX +15
Process temperature code H +40

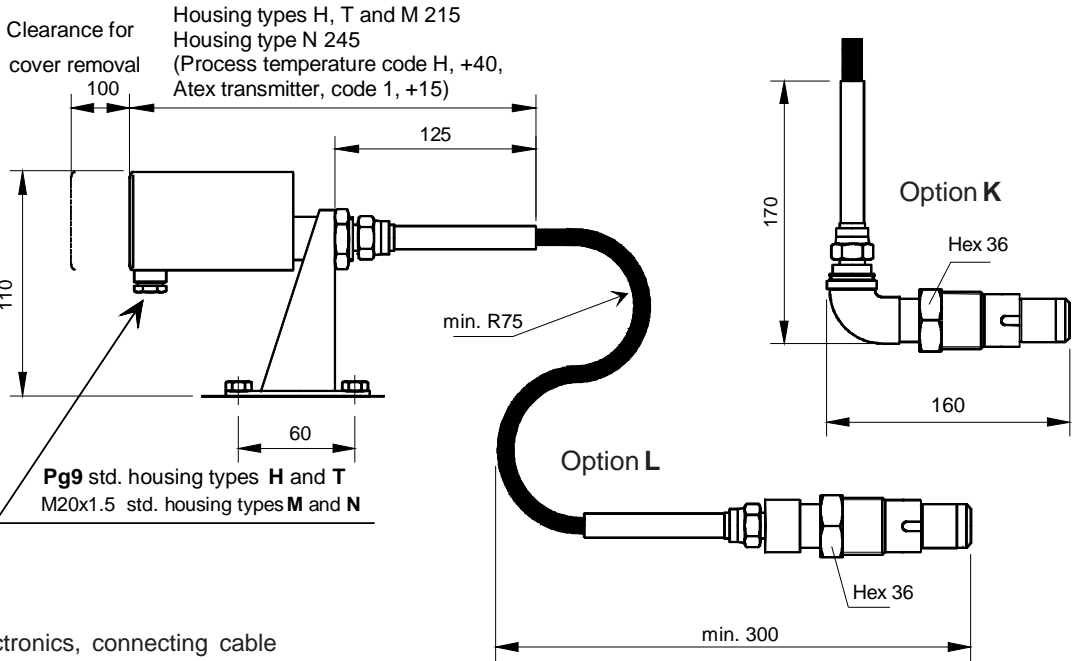
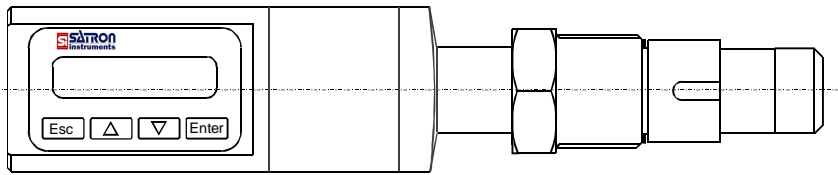
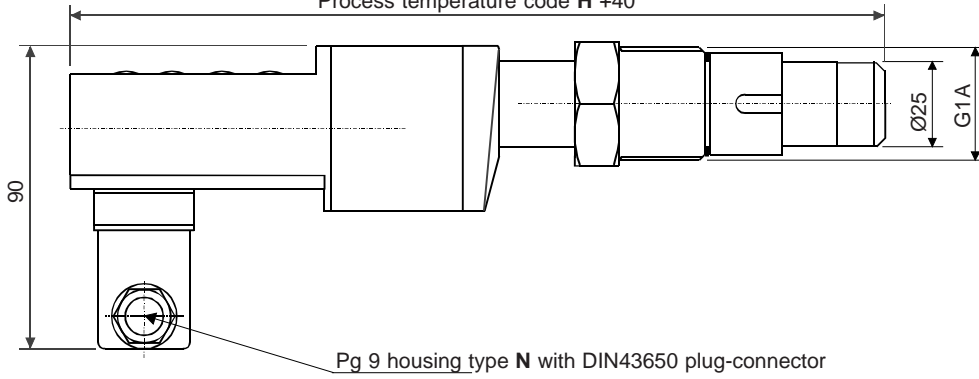

Remote electronics, connecting cable with protection hose, codes L and K

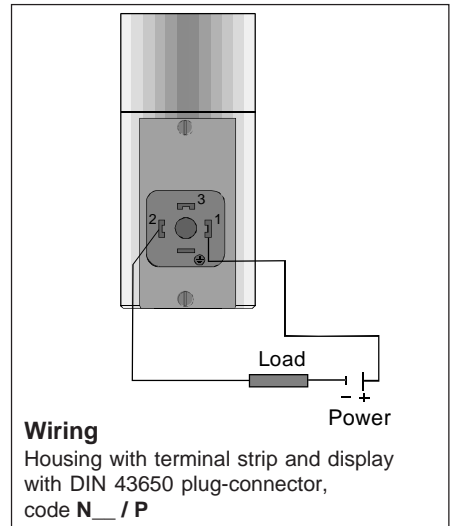
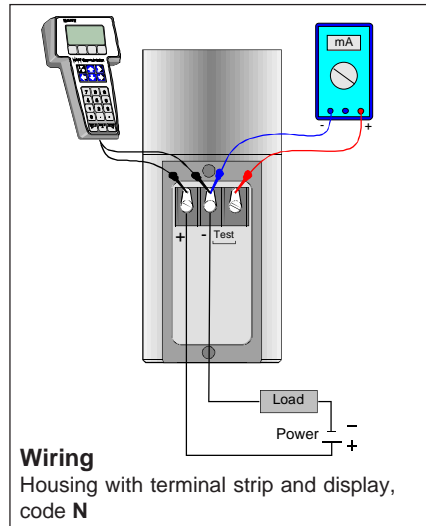
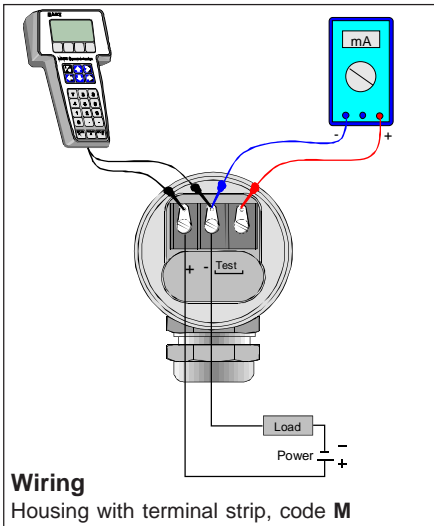

Couplings

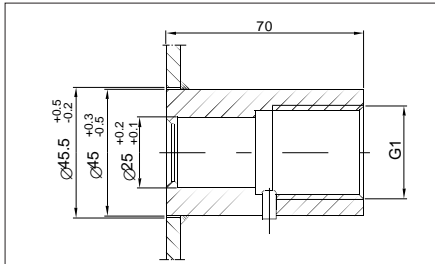

Standard coupling

Material: AISI316 L or Hastelloy C

Special couplings:

- G1 hygienic coupling, M548101
- G1/2A/G1 coupling, M546190
- G1/2A/G1 coupling with venting, M860280
- G1/2A/G1 couplings with bracket:
 - G1/2A male, M546195
 - G1/2 female, M550393

Transmitter's process sealing

Three different options are available for the transmitter's process sealing:

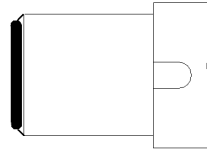
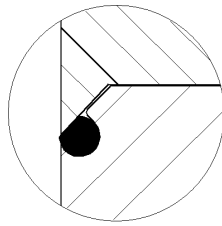

AISI316L, AISI317L or Duplex diaphragm, FPM (Viton) or EPDM O-ring (code 5 or 6) EHEDG - certified

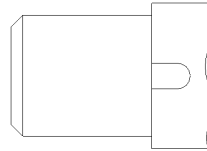
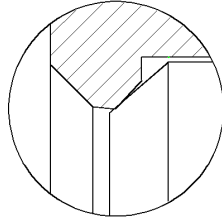

AISI316L, CoNi-, Duplex, Hastelloy C276, Tantalum or Titanium diaphragm, metal/metal taper sealing (diaphragm also on sealing face) (code 4)

Flanges:

Dimensions of flanged couplings, see the installation and setting-up instructions

PASVE® mounting & service valve

All PASVE® types are also available with pneumatic actuator, flushing and limit switches.

PASVE GF (NF)
(Flange type)

GP (NP)
(Welded on pipe)

GC (NC)
(Welded on container)

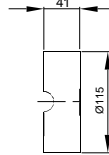
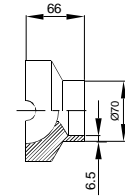
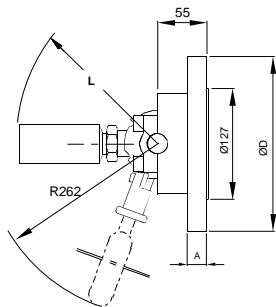

Process temperature limits, code H

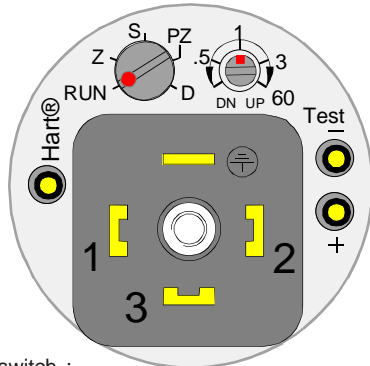
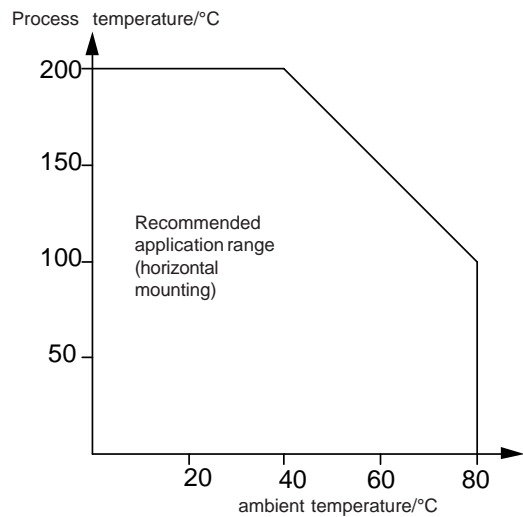

- Use of selector switch :
- RUN = working position
 - PZ = Process value zero
 - D = Damping adjustment
 - S = Span adjustment
 - Z = Zero adjustment
 - DN = Down
 - UP = Up

Housing with PLUG connector, housing code T



Keyboard :

- Esc = Press **Esc** move back towards the top of the main menu.
- ▲ = Use the **UP** arrow key to move up on the current menu level or to increase the selected parameter value.
- ▼ = Use the **DOWN** arrow key to move down on the current menu level or to decrease the selected parameter value.
- Enter = Press **ENTER** to move to a lower level in a menu or to accept a command or parameter value.

Housing with display, housing code N

Selection Chart

Adjustability	Span, min	Span, max	Measuring range
VG3	1.4 kPa (14 mbar)	35 kPa (350 mbar)	- 35...+35 kPa (-350...350 mbar)
VG4	4 kPa (40 mbar)	100 kPa (1000 mbar)	-100...+100 kPa (-1000...1000 mbar)
VG5	10 kPa (100 mbar)	500 kPa (5000 mbar)	-100...+500 kPa (-1000...5000 mbar)
VGA5	10 kPa (100 mbar)	500 kPa (5000 mbar)	0...+500 kPa (0...5000 mbar), abs.
VG6	0.03 MPa (0.3 bar)	3 MPa (30 bar)	-0.1...+3 MPa (-1...30 bar)
VGA6	0.03 MPa (0.3 bar)	3 MPa (30 bar)	0...+3 MPa (0...30 bar), abs.
VG7	0.15 MPa (1.5 bar)	15 MPa (150 bar)	0...+15 MPa (0...150 bar), abs.
VG8	1 MPa (10 bar)	25 MPa (250 bar)	-0,1...+25 MPa (-1...250 bar)

Output S 4-20mA DC/HART® -protocol

Process seal 4 metal/metal taper 5 O-ring FPM (Viton®) (1) 6 O-ring EPDM (1)

Wetted materials

Code	Material	Code	Material
2	AISI316L (EN 1.4435)	6	Titanium Gr2 (*) (**) (****)
3	Hast. C 276 (*) (**)	7	CoNi-alloy (*) (not ranges 3-4)
5	Tantalum (*) (**)	8	Duplex (EN 1.4462) (*) (**)

Diaphragm coating

Code	Material
9	gold/Rhodium
Y	diamond (specify only when coated)

Fill fluid S Silicon oil G Inert oil A Food and beverage special oil (Neobee M20)

Housing type

H	Housing with PLUG-connector, DIN43650, no display, inlet PG9
T	Housing with PLUG-connector and with manual adjust, DIN43650, no display, inlet PG9, (no ATEX)
M	Housing with junction box/terminal strip, no display, inlet M20x1,5
N	Housing with junction box/terminal strip, with display, inlet M20x1,5

Explosion proof 0 No explosion proof classification 1 Atex Intrinsic Safety,  II 1 GD T135°C (***)

Process temperature limits N -30 ... +125 °C H 0 ... +200 °C (*) (**)



Process coupling

0 No coupling E Hygienic coupling
G Standard coupling

Material

2 AISI316L
3 Hast.C276
6 Titanium Gr2
8 Duplex

PASVE® mounting valve, specify separately in the order
Specify special couplings separately in the order

Special size of electrical inlet

N 1/2 NPT G Pg13.5 P Plug connector DIN 43650

Special features

Remote electronics (specify only if housing connected with cable to sensing element)

- connecting cable with protection hose

L Hose protected with PTFE/AISI316 braiding, straight
K Hose protected with PTFE/AISI316 braiding, angle of 90°

Length of connection cable between sensing element and housing

2 2 m cable 3 3 m cable etc. (max. 10 m)

Mounting parts for remote electronics for Ø 51 mm tube

0 No mounting parts 1 Mounting parts

Documentation

Calibration certificate AE English

Installation and operating instructions IE English IF Finnish

Material certificates

0 No material certificate
MC1 Raw material certificate without appendices, in accordance with SFS-EN 10204-2.1 (DIN 50049-2.1) standard
MC2 Raw material certificate for wetted parts, in accordance with SFS-EN 10204-2.2 (DIN 50049-2.2) standard
MC3 Raw material certificate for wetted parts, in accordance with SFS-EN 10204-3.1 B (DIN 50049-3.1 B) standard

We reserve the right for technical modifications without prior notice.

HART is the registered trademark of HART Communication Foundation.
Pasve is the registered trademark of Satron Instruments Inc.
Hastelloy is the registered trademark of Haynes International.
Teflon is the registered trademark of E.I. du Pont de Nemours & Co.
Viton is the registered trademark of DuPont Down Elastomer.



(*) = only process seal code 4
(**) = not for range 3
(***) = Housing H and N :  II 2 GD T135°C
ATEX transmitters with display are the model without membrane key.
(****) = Min. process temperature limits 0 °C
(1) = EHEDG - certified