

User Guide

HMD60 Series Humidity and Temperature
Transmitters for Ducts in HVAC

HMD62 TMD62

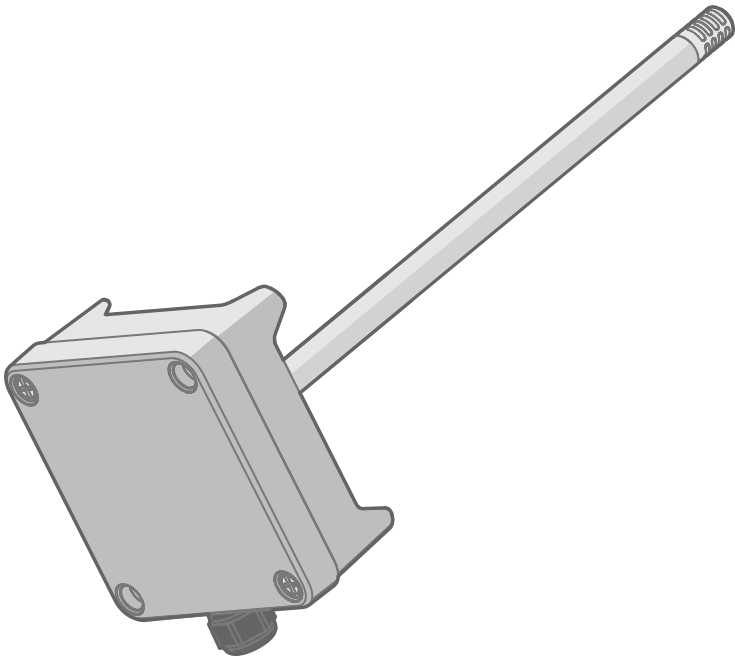

VAISALA

PUBLISHED BY

Vaisala Oyj
Vanha Nurmijärventie 21, FI-01670 Vantaa, Finland
P.O. Box 26, FI-00421 Helsinki, Finland
+358 9 8949 1

Visit our Internet pages at www.vaisala.com.

© Vaisala Oyj 2019

No part of this document may be reproduced, published or publicly displayed in any form or by any means, electronic or mechanical (including photocopying), nor may its contents be modified, translated, adapted, sold or disclosed to a third party without prior written permission of the copyright holder. Translated documents and translated portions of multilingual documents are based on the original English versions. In ambiguous cases, the English versions are applicable, not the translations.

The contents of this document are subject to change without prior notice.

Local rules and regulations may vary and they shall take precedence over the information contained in this document. Vaisala makes no representations on this document's compliance with the local rules and regulations applicable at any given time, and hereby disclaims any and all responsibilities related thereto.

This document does not create any legally binding obligations for Vaisala towards customers or end users. All legally binding

obligations and agreements are included exclusively in the applicable supply contract or the General Conditions of Sale and General Conditions of Service of Vaisala.

This product contains software developed by Vaisala or third parties. Use of the software is governed by license terms and conditions included in the applicable supply contract or, in the absence of separate license terms and conditions, by the General License Conditions of Vaisala Group.

This product may contain open source software (OSS) components. In the event this product contains OSS components, then such OSS is governed by the terms and conditions of the applicable OSS licenses, and you are bound by the terms and conditions of such licenses in connection with your use and distribution of the OSS in this product. Applicable OSS licenses are included in the product itself or provided to you on any other applicable media, depending on each individual product and the product items delivered to you.

Table of Contents

1.	About This Document	3
1.1	Version Information.....	3
1.2	Related Manuals.....	3
1.3	Documentation Conventions.....	3
1.4	Trademarks.....	4
2.	Product Overview	5
2.1	Introduction to HMD60 Series.....	5
2.2	HMD62 and TMD62 Basic Features and Options.....	5
2.3	Available Parameters and Default Scaling.....	5
2.4	Connectivity to Vaisala Insight Software.....	6
2.5	Transmitter Parts.....	7
2.5.1	Cable Gland and Conduit Options.....	8
2.5.2	Filter Options.....	8
2.5.3	Transmitter Board.....	9
2.5.4	Trimmers.....	10
2.5.5	DIP Switch Output Selection (HMD62).....	11
2.6	Filtering Factor.....	12
2.7	Environmental Compensation (HMD62).....	12
3.	Installation	13
3.1	Transmitter Dimensions.....	13
3.2	Duct Mounting Overview.....	14
3.3	Installing into Duct.....	15
3.4	Wiring.....	16
4.	Calibration and Adjustment	18
4.1	Calibration and Adjustment Overview.....	18
4.2	Calibration and Adjustment Using Trimmers.....	18
4.2.1	1-Point Adjustment Using Trimmers and Reference Calibrator.....	19
4.2.2	Adjusting Output Using Trimmers and Reference Transmitter (1-point adjustment).....	19
4.2.3	Resetting Trimmers Back to Zero.....	20
4.3	Calibration and Adjustment with Insight PC Software.....	21
4.3.1	2-Point Adjustment with Insight and Reference Calibrator.....	22
4.3.2	1-Point Adjustment with Insight and Reference Transmitter.....	23
4.4	Calibration and Adjustment with MI70 Hand-Held Indicator.....	24
4.4.1	1-Point Adjustment Using Reference Environment.....	24
5.	Operating with Insight PC Software	27
5.1	Vaisala Insight Software.....	27
5.2	Connecting to Insight Software.....	27
5.3	Insight Main View.....	28
5.3.1	Basic and Advanced User Modes.....	29
5.4	Configuring Analog Outputs with Insight.....	29
5.4.1	Testing and Adjusting Analog Output Current (mA) Level.....	30

5.5	Configuring Minimum and Maximum RH and T Errors with Insight.....	31
5.6	Changing Pressure Compensation Settings with Insight (HMD62).....	33
5.7	Setting Filtering Factor with Insight.....	34
6.	Operating with MI70 Indicator.....	35
6.1	Overview of MI70 Support.....	35
6.1.1	MI70 Indicator Parts.....	35
6.2	Connecting HMD60 to MI70 Indicator.....	36
6.3	Basic Display.....	37
6.4	Graphical Display.....	37
6.5	Main Menu.....	38
6.6	Holding and Saving the Display.....	38
6.7	Recording Data.....	39
7.	Maintenance and Troubleshooting.....	40
7.1	Cleaning.....	40
8.	Technical Data.....	41
8.1	Specifications.....	41
8.2	Spare Parts and Accessories.....	43
8.3	Transmitter Dimensions.....	44
	Warranty.....	45
	Technical Support.....	45
	Recycling.....	45

1. About This Document

1.1 Version Information

Table 1 Document versions

Document Code	Date	Description
M212016EN-B	May 2019	This manual. Added information about short probe option and the HMD65 transmitter model, updated the information on the effect of DIP switch parameter selection on Insight configuration. Corrected filtering factor formula. Stability specification corrected, lead-through and plug appearance updated in illustrations.
M212016EN-A	September 2018	First version of the document.

1.2 Related Manuals

Table 2 Related Manuals

Document Code	Description
M212049EN	HMD62 and TMD62 Multilingual Quick Guide (languages: English, German, French, Spanish, Portuguese, Russian, Chinese, Japanese)
M212243EN	HMD65 User Guide in English
M212264EN	HMD65 Multilingual Quick Guide (languages: English, German, French, Spanish, Portuguese, Russian, Chinese, Japanese)

1.3 Documentation Conventions



WARNING! alerts you to a serious hazard. If you do not read and follow instructions carefully at this point, there is a risk of injury or even death.



CAUTION! warns you of a potential hazard. If you do not read and follow instructions carefully at this point, the product could be damaged or important data could be lost.



Note highlights important information on using the product.



Tip gives information for using the product more efficiently.

1.4 Trademarks

Vaisala® and HUMICAP® are registered trademarks of Vaisala Oyj.

Windows® is either a registered trademark or trademark of Microsoft Corporation in the United States and other countries.

All other product or company names that may be mentioned in this publication are trade names, trademarks, or registered trademarks of their respective owners.

2. Product Overview

2.1 Introduction to HMD60 Series

The duct mounted HMD60 HUMICAP® Humidity and Temperature Transmitters are designed for monitoring humidity and temperature in demanding HVAC and light industrial applications. HMD60 series transmitters provide stable, reliable, and highly accurate (up to $\pm 1.5\%$ RH and $\pm 0.1\text{ }^{\circ}\text{C}$ ($0.18\text{ }^{\circ}\text{F}$)) measurements, and are resistant to chemicals and dust.

HMD60 series transmitter options include 2 analog output models: HMD62 for measuring both humidity and temperature, and TMD62 for temperature measurements. Both HMD62 and TMD62 use 4 ... 20 mA loop powered current output. The HMD65 transmitter model includes both analog and digital output options.

Thanks to easy access to electronics also when the transmitter is installed to a duct, configuration and adjustment can be carried out quickly and conveniently. Available configuration and adjustment interface options range from physical trimmers and DIP switches on the transmitter's circuit board to Vaisala Insight PC software for Windows®.

2.2 HMD62 and TMD62 Basic Features and Options

- Measurement options:
 - HMD62 for humidity and temperature measurement
 - TMD62 for temperature measurement
- Humidity parameters available as output options in HMD62: RH, T_{d} , T_{df} , A, X, T_{w} , H
- Analog output: 4 ... 20 mA, loop powered
 - HMD62: 2 analog output channels for humidity and temperature measurements
 - TMD62: 1 analog output channel for temperature measurement
- Power supply input: 10 ... 35 VDC / 20 ... 35 VDC
- Configuration and adjustment options:
 - RH and T measurement field adjustment with trimmers
 - Humidity output parameter selection with DIP switches (HMD62)
 - Field adjustment with MI70 hand-held indicator
 - Configuration and adjustment with Vaisala Insight PC software

2.3 Available Parameters and Default Scaling

HMD62 Measurement Parameters and Default Analog Output Scaling

Table 3 (page 6) shows the available output parameters and the default analog output scaling of the parameters for HMD62.

Table 3 HMD62 Measurement Parameters and Default Scaling

Parameter	Default Scaling for 4 ... 20 mA Output Range
Relative humidity (RH)	0 ... 100 %RH
Temperature (T)	-20 ... +80 °C (-4 ... +176 °F)
Dew point temperature (T_d)	-40 ... +80 °C (-40 ... +176 °F)
Dew point/frost point temperature (T_{df})	-40 ... +80 °C (-40 ... +176 °F)
Absolute humidity (A)	0 ... 300 g/m ³ (0 ... 131.1 gr/ft ³)
Mixing ratio (X)	0 ... 600 g/kg (0 ... 4200 gr/lb)
Wet-bulb temperature (T_w)	-40 ... +80 °C (-40 ... +176 °F)
Enthalpy (H)	-40 ... 1600 kJ/kg (-9.5 ... 695.6 Btu/lb)

TMD62 Measurement Parameters and Default Analog Output Scaling

Table 4 (page 6) shows the available output parameters and the default analog output scaling of the parameters for TMD62.

Table 4 TMD62 Measurement Parameters and Default Scaling

Parameter	Default Scaling for 4 ... 20 mA Output Range
Temperature (T)	-20 ... +80 °C (-4 ... +176 °F)

Changing Measurement Parameter Scaling

If your application requires an analog output scaling that differs from the defaults shown in Table 3 (page 6) and Table 4 (page 6), you can configure the scaling by connecting the transmitter to Vaisala Insight PC software (requires Vaisala USB cable 219690).

2.4 Connectivity to Vaisala Insight Software

The transmitter can be connected to Vaisala Insight software using a Vaisala USB cable (order code 219690). With the Insight software, you can:

- Calibrate and adjust the measurement.
- See device information and status.
- See real-time measurement.
- Configure output parameters and scaling.

More Information

- [Connecting to Insight Software \(page 27\)](#)

2.5 Transmitter Parts

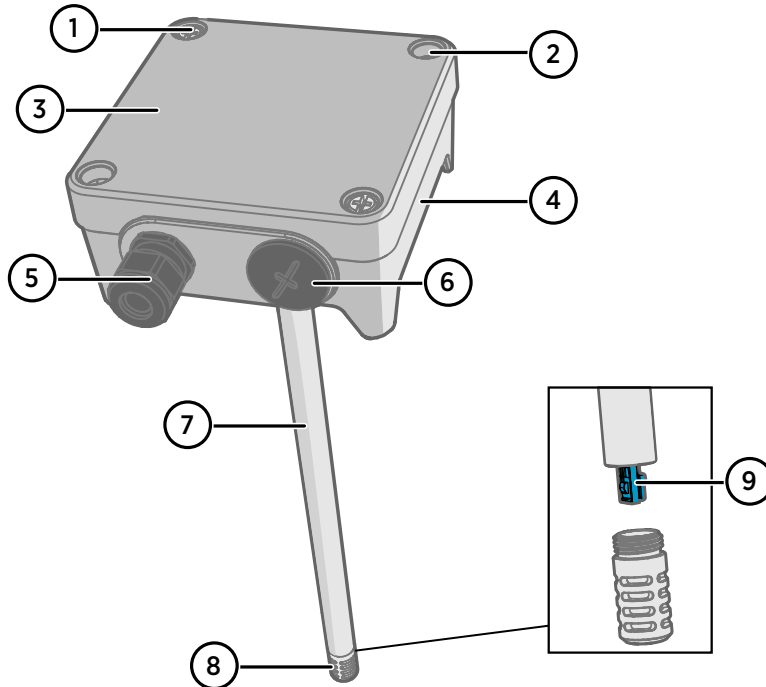

Figure 1 HMD62 and TMD62 Transmitter Parts Overview

- 1 Captive screw (2 pcs, cross-head) for attaching the lid of the transmitter.
- 2 Screw (2 pcs) for mounting the transmitter on the installation surface.
- 3 Transmitter lid. Open the captive screws of the lid to access input and output electronics.
- 4 Transmitter base. Contains the input and output connectors on the transmitter board: see [Transmitter Board \(page 9\)](#).
- 5 Cable gland (M16 x 1.5 lead-through) for leading wires into the transmitter.
- 6 Alternative lead-through (M20 x 1.5) for wiring.
- 7 Probe body. Long (shown) and short probe options available: see [Transmitter Dimensions \(page 13\)](#).
- 8 Probe filter (default option: AISI 316L stainless steel).
- 9 HUMICAP® sensor inside the probe filter.



CAUTION! Do not touch the sensor element.

2.5.1 Cable Gland and Conduit Options

HMD60 has 2 lead-throughs (M16x1.5 and M20x1.5) that can be used with a variety of cable gland and conduit options. [Figure 2 \(page 8\)](#) shows the cable gland and conduit options available from Vaisala.

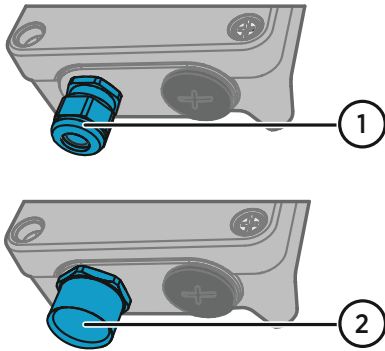

Figure 2 HMD60 Cable Gland and Conduit Options

- 1 Cable Gland and O-ring M16 x 1.5 (Vaisala order code: 254280SP). This is the default option delivered with HMD60.
- 2 Conduit fitting and O-ring (M16x1.5 / NPT1/2") (Vaisala order code: 210675SP).

2.5.2 Filter Options

[Figure 3 \(page 8\)](#) shows the filter options available for HMD60.

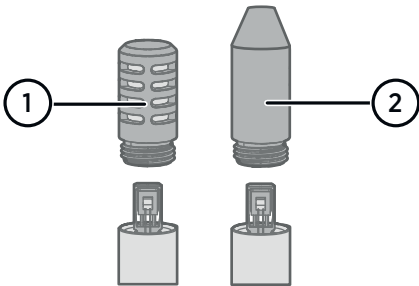

Figure 3 HMD60 Filter Options

- 1 Metal Grid with PTFE Membrane (Vaisala order code ASM212652SP). This is the default option delivered with HMD60.
- 2 Sintered Filter (Vaisala order code HM46670SP).

2.5.3 Transmitter Board

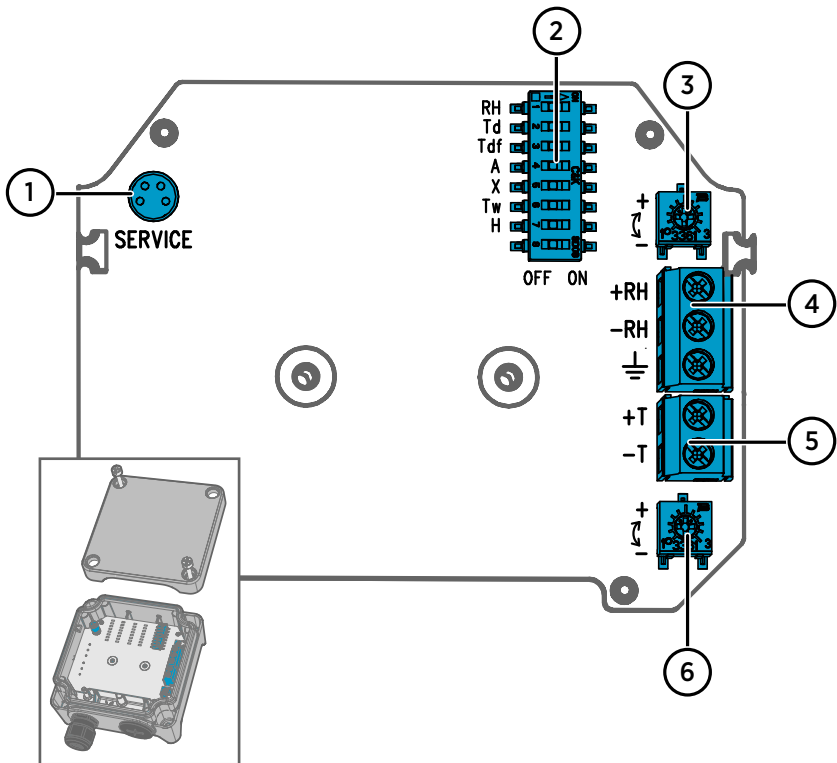

Figure 4 HMD60 Transmitter Board: Service Port, DIP switches, Trimmers and Screw Terminals

- 1 Service port for MI70 hand-held indicator and Insight PC software cable connection.
- 2 DIP switches for humidity parameter selection (HMD62).
- 3 Trimmer for humidity measurement adjustment (HMD62).
- 4 Screw terminals for humidity measurement output (HMD62).
- 5 Screw terminals for temperature measurement output.
- 6 Trimmer for temperature measurement adjustment.



The HMD62 board (shown in [Figure 4 \(page 9\)](#)) includes options for both humidity and temperature output. The TMD62 board includes only components limited to temperature output options. See [Wiring \(page 16\)](#) for more information.

2.5.4 Trimmers

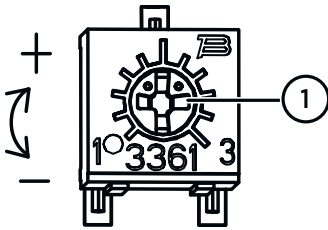

Figure 5 Component Board Adjustment Trimmer

- 1 Use a Phillips head screwdriver (PH0) to rotate the RH or T adjustment trimmer. To increase the measurement output value, rotate the trimmer clockwise. To decrease, rotate counterclockwise.
Note that there is a slight delay before the measurement output changes after rotating the trimmer.

You can adjust the transmitter's RH (HMD62) or T (HMD62 and TMD62) measurement output with the trimmers on the component board. During trimmer adjustment, the output of the transmitter is corrected using the trimmers until the output matches the known value of a reference.

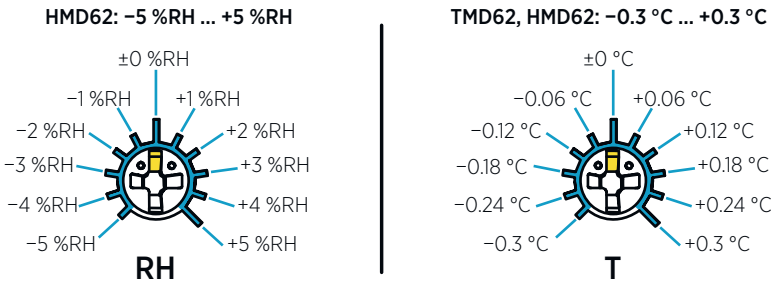

Figure 6 RH and T Trimmer Adjustment Ranges (Indicative)



You can only calibrate the relative humidity measurement (RH) and temperature measurement (T). Other parameters (available for HMD62) are calculated internally based on RH and T. Check that the output selection DIP switch is set to RH when making adjustments with the physical trimmer; when using the Insight PC software, set all DIP switches to the **OFF** position.



CAUTION! If you use the Insight PC software to adjust the measurement or to restore the factory settings, always return the physical trimmer to the middle position before starting. When you make an adjustment with Insight, the position in which the trimmer is at that point is set as the ± 0 point.

2.5.5 DIP Switch Output Selection (HMD62)

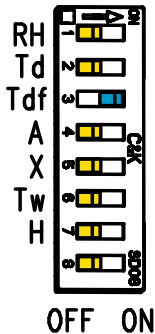

Figure 7 HMD62 DIP Switch Example: T_{df} Output Selected

- RH Relative humidity
- Td Dew point temperature
- Tdf Dew point/frost point temperature
- A Absolute humidity
- X Mixing ratio
- Tw Wet-bulb temperature
- H Enthalpy

You can change the humidity parameter that is output on the RH channel of HMD62 with the DIP switches on the component board. Select the parameter you want the transmitter to output by sliding the parameter’s DIP switch to the right (**ON**). In the example in [Figure 7 \(page 11\)](#), the transmitter’s selected output parameter is dew point/frost point temperature (T_{df}). Keep the other DIP switches in the **OFF** position (left).

The selected parameter uses the default scaling shown in [Table 5 \(page 11\)](#).

Table 5 HMD62 Default Parameter Scaling

Parameter	Default Scaling for 4 ... 20 mA Output Range
RH	0 ... 100 %RH
T_d	-40 ... +80 °C (-40 ... +176 °F)
T_{df}	-40 ... +80 °C (-40 ... +176 °F)
A	0 ... 300 g/m ³ (0 ... 131.1 gr/ft ³)
X	0 ... 600 g/kg (0 ... 4200 gr/lb)
T_w	-40 ... +80 °C (-40 ... +176 °F)
H	-40 ... 1600 kJ/kg (-9.5 ... 695.6 Btu/lb)



CAUTION! Note that the humidity output parameter selected with the DIP switches on the transmitter component board will be used instead of the parameter selected with Insight. When using Insight to configure the output, set all humidity parameter selection DIP switches on the transmitter component board to the **OFF** position (left) to ensure they do not cause a conflict with the Insight settings.



HMD62 only: If you use Insight to set both analog output channels to output T measurement, the humidity parameter DIP switches do not have an effect on the output.

2.6 Filtering Factor

If the measuring environment produces occasional exceptionally high or low readings that need to be averaged out in the output, you can apply a filtering factor to the RH or T output (filtering factor range: 0.001 ... 1.000). The filtering factor defines the speed at which the latest measurement is integrated into the transmitter's output. By default, the filtering factor is set to 0.500, which means that the displayed output is a 50%+50% combination of the previous measurement and the most recent measurement. To show the latest measurement directly in the output, set the filtering factor to 1.000 (no filtering).

The following formula is used when calculating the output:

$$\text{output} = [(\text{new (unfiltered) measurement} \times \text{filtering factor}) + (\text{previous output} \times (1.0 - \text{filtering factor}))]$$

The filtering factor can be configured with the Insight PC software.

More Information

- [Setting Filtering Factor with Insight \(page 34\)](#)

2.7 Environmental Compensation (HMD62)

By default, the pressure value used in HMD62 measurement calculation is 1013.2 hPa. If the pressure of your measurement environment differs from this, you can configure the transmitter's pressure compensation value with the Insight PC software.

More Information

- [Changing Pressure Compensation Settings with Insight \(HMD62\) \(page 33\)](#)

3. Installation

3.1 Transmitter Dimensions

The dimensions are given in millimeters and [inches].

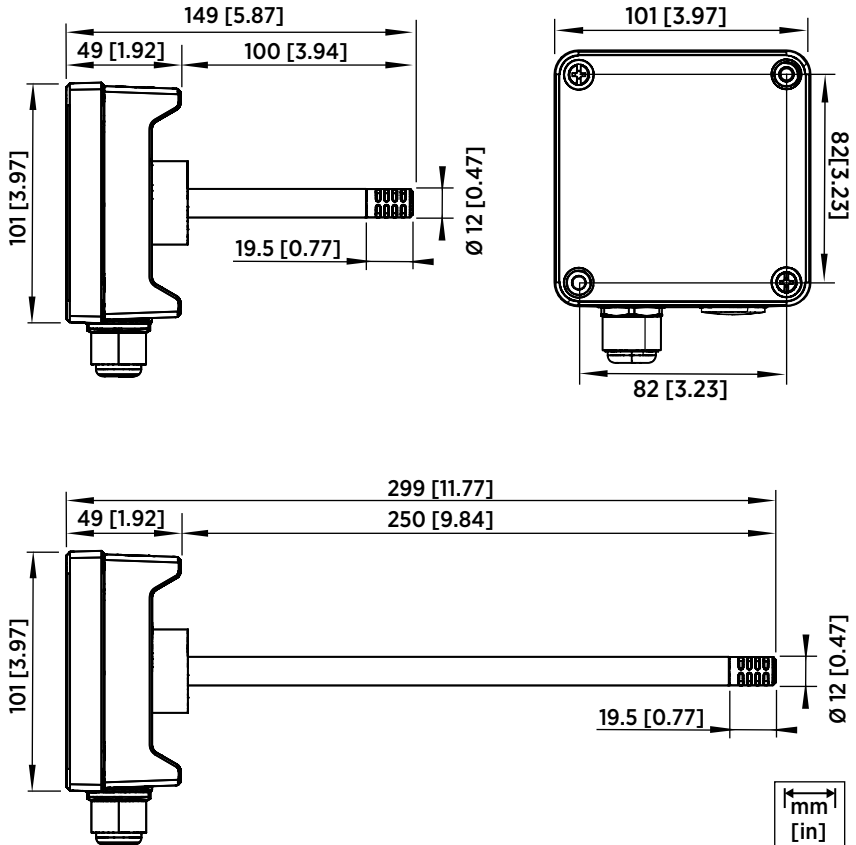

Figure 8 Dimensions with Long and Short Probe

3.2 Duct Mounting Overview

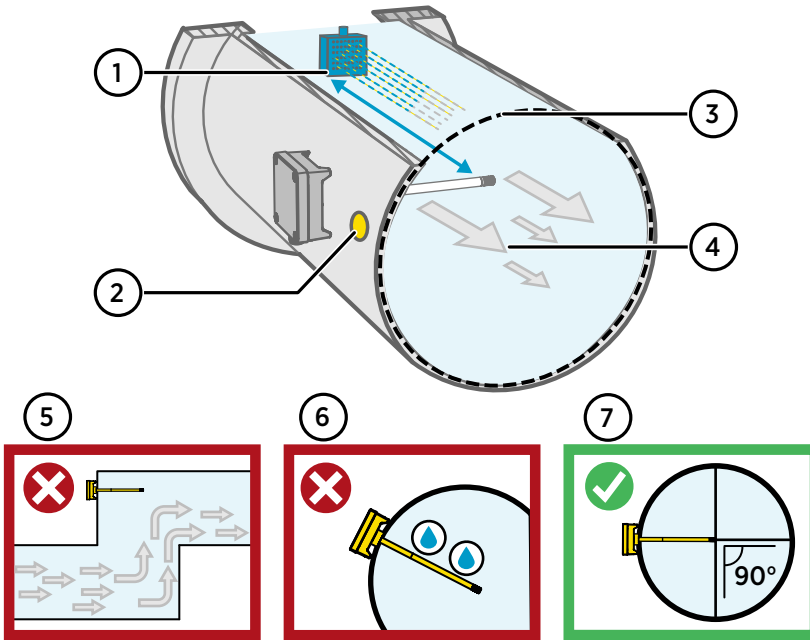

Figure 9 Duct Installation Overview

- 1 Make sure there is a minimum clearance of 5 m (16.5 ft) between the probe body and any possible humidifier. Avoid installing in a location where condensation can fall on the sensor inside the duct.
- 2 When installing the transmitter, drill a second hole approximately 30 cm (12 in) from the installation hole, towards the direction of the air flow, and plug it with a removable seal. This second hole is intended for later use in reference measurement with another device when calibrating or adjusting the transmitter.
- 3 Check that the duct diameter is suitable for the probe body (see [Transmitter Dimensions \(page 13\)](#)). Ideally, the sensor (probe head) should be installed in the middle of the duct.
- 4 Maximum air flow speed: 50 m/s (with sintered filter).
- 5 Avoid installing the transmitter in dead legs. Supersaturation can occur in areas where there is no air flow.
- 6 Do not install the probe in a downward angle. Condensation can travel to the sensor along the probe body if the probe points down.
- 7 Install the probe in a 90° angle so that the sensor is placed as close to the middle of the duct as possible.

3.3 Installing into Duct



- Medium size crosshead screwdriver for mounting screws and lid screws.
- Small slotted screwdriver for screw terminals.
- Drill with 3.5 mm (0.14 in) and 13 ... 15 mm (0.51 ... 0.59 in) bits for making the installation holes.
- Tools for cutting and stripping wires.

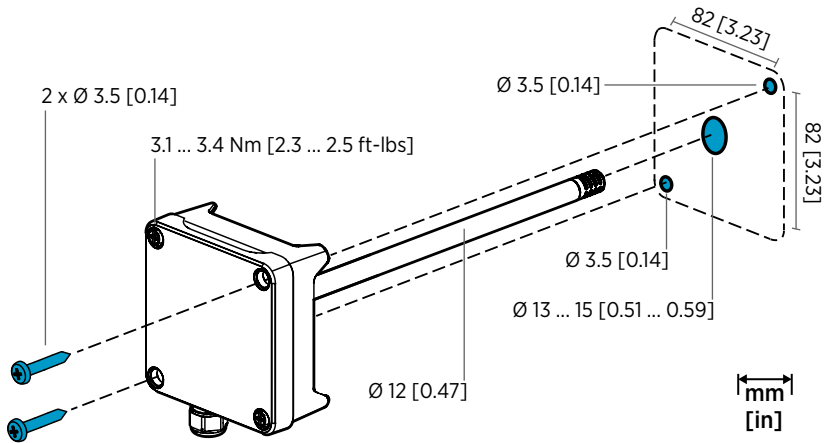

Figure 10 Drilling and Mounting Screws

- ▶ 1. Select an installation location for the transmitter on the duct surface and drill a $\text{Ø } 13 \dots 15 \text{ mm}$ (0.51 ... 0.59 in) hole for inserting the probe.
2. Push the probe through the hole on the duct until the transmitter body meets the duct.
3. Attach the transmitter body to the duct with 2 $\text{Ø } 3.5 \text{ mm}$ (0.14 in) screws.



Check that the insulation ring sits tightly over the installation hole. If the duct has a negative pressure, external air can be drawn into the duct and affect the measurement if the installation hole is not sealed tightly.

4. Optional: Drill a second hole for reference measurements approximately 30 cm (12 in) from the transmitter installation hole. See [Figure 9 \(page 14\)](#).
5. Open the 2 captive screws on the transmitter body and remove the lid.
6. Attach the input/output wiring to the screw terminals on the transmitter component board. See [Wiring \(page 16\)](#). Tighten cable glands firmly after wiring.
7. Check that the DIP switches and trimmers are in the correct position. See [DIP Switch Output Selection \(HMD62\) \(page 11\)](#) and [Trimmers \(page 10\)](#).

8. Close the transmitter lid and switch on the transmitter's power supply input.

3.4 Wiring

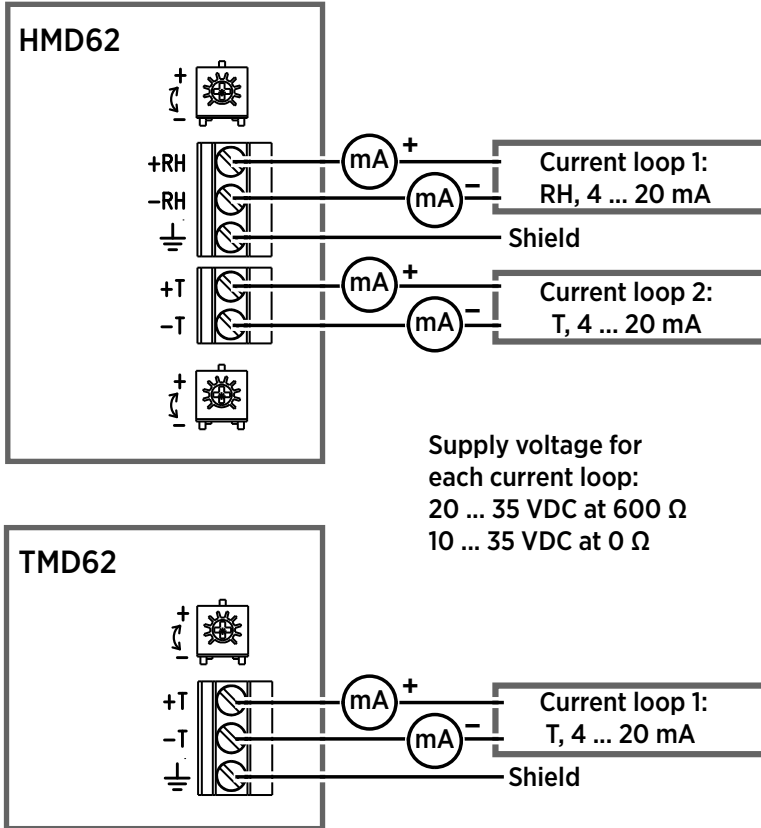

Figure 11 HMD62 and TMD62 Wiring Diagrams



- Screw terminal wire size: 0.5 ... 2.5 mm²
- Flat head screwdriver: 0.6×3.5 mm



WARNING! Make sure that you prepare or connect only de-energized wires.



Using a power supply with overload protection is recommended for electrical safety.

4. Calibration and Adjustment

4.1 Calibration and Adjustment Overview

You can calibrate or adjust the transmitter's measurement output using one of the following options:

- 1-point adjustment with the RH and T trimmers on the HMD60 component board (adjustment range: -5%RH ... +5 %RH and -0.3 °C ... +0.3 °C (-0.54 °F ... +0.54 °F).
- 1-point or 2-point adjustment by connecting the transmitter to Vaisala Insight PC software (requires USB cable 219690).
- 1-point adjustment by connecting the transmitter to an MI70 hand-held indicator (requires MI70 connection cable 219980SP).

4.2 Calibration and Adjustment Using Trimmers

HMD60 transmitters have 2 separate trimmers for RH and T measurement output adjustment mounted on the component board. The trimmers allow for easy 1-point adjustment of the measurement output against a reference with a known value.

The transmitters are shipped with the trimmers centered. Turning the trimmer counter-clockwise decreases the measurement output value, and turning clockwise increases the value. [Figure 12 \(page 18\)](#) shows the trimmer adjustment ranges for RH and T (-5 %RH ... +5 %RH and -0.3 °C ... +0.3 °C (-0.54 °F ... +0.54 °F).

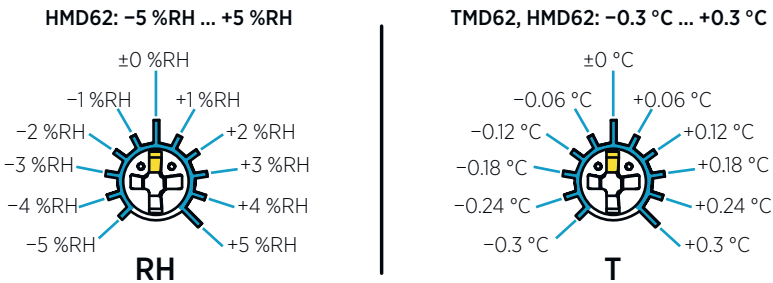

Figure 12 RH and T Adjustment Trimmer Ranges (Indicative)



The trimmers will only turn 135 degrees each way, less than half a rotation. Do not force the trimmer past the stopping point.



CAUTION! If you use the Insight PC software to adjust the measurement or to restore the factory settings, always return the physical trimmer to the middle position before starting. When you make an adjustment with Insight, the position in which the trimmer is at that point is set as the ± 0 point.

4.2.1 1-Point Adjustment Using Trimmers and Reference Calibrator



- Reference environment(s) for producing the desired humidity and/or temperature (for example, Vaisala HMK15 Humidity Calibrator).
- A multimeter for checking the analog output reading (connect in series to measure the current output).
- Small Phillips head screwdriver for turning the trimmers.

To adjust the output:

- ▶ 1. Prepare the reference (for example, a humidity calibrator). Use a reference that matches your normal measurement environment as closely as possible.
2. Connect the multimeter to the analog output (connect in series to measure the current output).
3. Insert the probe head in the reference environment.
4. Wait for the reference measurement to stabilize fully. This may take more than 30 minutes. Monitor the readings to see when the measurement has stabilized.
5. When the measurement has stabilized, adjust the output with the trimmers until it matches the known value of the reference.



Note that there is a small delay before the output value updates after you turn the trimmer.

4.2.2 Adjusting Output Using Trimmers and Reference Transmitter (1-point adjustment)



- A recently calibrated reference device (for example, a second HMD60 transmitter).
- A multimeter for checking the analog output reading (connect in series to measure the current output).
- Small Phillips head screwdriver for turning the trimmers.



It is assumed that a hole was drilled for the reference instrument during installation, the transmitter is powered, and you can view the measurement output value.

To adjust the output:

- ▶ 1. Insert the reference transmitter into the measurement environment next to the transmitter that you are adjusting. The reference transmitter should be inserted approximately 30 cm (12 in) from the HMD60 probe's installation hole, towards the direction of the air flow. See [Figure 9 \(page 14\)](#).
2. Connect a multimeter to the analog output of the reference transmitter (connect in series to measure the current output).
3. Wait for the measurement to stabilize fully. This may take more than 30 minutes. Monitor the readings to see when the measurement has stabilized.
4. When the measurement has stabilized, adjust the output of your transmitter with the trimmers until it matches the output of the reference transmitter.



Note that there is a small delay before the output value updates after turning the trimmer.

5. When done, plug the installation hole of the reference transmitter.

4.2.3 Resetting Trimmers Back to Zero



- Computer with Windows operating system and Vaisala Insight software installed
- Vaisala USB cable 219690 for connecting the probe
- Small Phillips head screwdriver for turning the trimmer(s)

If you need to reset a trimmer back to zero (± 0 point), use the Insight PC software to restore factory adjustments for the parameter the trimmer adjusts (RH or T).

- ▶ 1. Turn the trimmer(s) back to the middle position (± 0 point)
2. Connect the transmitter to Insight. See [Connecting to Insight Software \(page 27\)](#).
3. Select  > **Calibrate** > **Yes** to switch the probe to calibration mode.
4. Select the parameter you want to reset (**RH adjustment** or **T adjustment**).
5. Select **Restore factory adjustment** and confirm by selecting **Yes**.
6. Reset each parameter (RH or T) separately as needed with the trimmer turned back to the middle position (± 0 point). The trimmer adjustment now starts from the ± 0 point of the default trimmer adjustment range (see [Calibration and Adjustment Using Trimmers \(page 18\)](#)).

4.3 Calibration and Adjustment with Insight PC Software

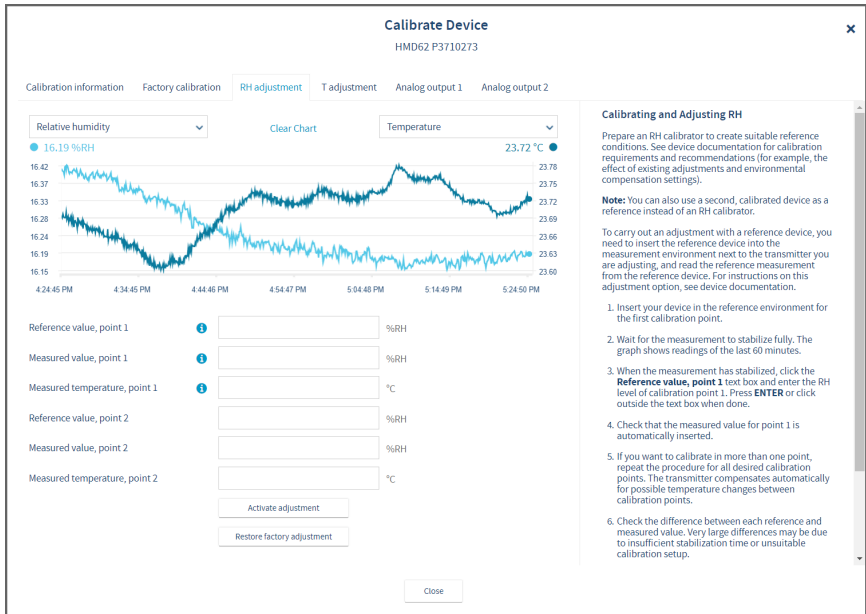

Figure 13 Insight Calibration View (HMD62 Example)

You can use the Insight PC software to calibrate and adjust the RH or T measurement in 1 or 2 points. Either a reference environment (such as a humidity calibrator) or a reference instrument (for example, a second HMD60 transmitter) can be used when adjusting.



CAUTION! When you use the Insight PC software to adjust the measurement or to restore the factory settings, always return the physical adjustment trimmer(s) on the transmitter component board to the middle position before starting. When you make an adjustment with Insight, the position in which the adjustment trimmer is at that point is set as the ± 0 point.

More Information

- [Connecting to Insight Software \(page 27\)](#)

4.3.1 2-Point Adjustment with Insight and Reference Calibrator



- Computer with Windows operating system and Vaisala Insight software installed
- Vaisala USB cable 219690 for connecting the probe
- Reference environment(s) for producing the desired humidity and/or temperature

This procedure can be used to adjust the humidity (RH) or temperature (T) measurement of the transmitter. If you want to adjust both RH and T (**HMD62**), repeat the procedure for each parameter.

Because stabilization of temperature and humidity takes time, you should expect the adjustment procedure to take at least 30 minutes for each adjustment point.

- ▶ 1. Prepare the reference environment (for example, Vaisala HMK15 Humidity Calibrator).
2. Connect the transmitter to Insight. See [Connecting to Insight Software \(page 27\)](#).
3. Select  > **Calibrate** > **Yes** to switch the probe to calibration mode.
In calibration mode, the device will not use functions that may interfere with calibration and adjustment.
4. Select the type of adjustment to perform: **RH adjustment** or **T adjustment**.
5. Define the needed adjustment for the first measurement point:
 - a. Insert the probe head in the reference environment for the first calibration point.
 - b. Wait for the measurement to stabilize fully.
 - c. Click the **Reference value, point 1** text box and enter the reference value of the calibration point. Press **ENTER** or click outside the text box when done.
 - d. Insight automatically enters the measured values for the calibration point.
6. Repeat [step 5](#) for the second calibration point.
7. Select **Activate adjustment** > **Yes** to store the adjustment in the transmitter.
8. Check the message that appears at the top of the screen. If the message indicates that the adjustment is activated successfully, your adjustment is stored.
9. Select the **Calibration information** tab and update the **Calibration date** and **Calibration text**.
10. Select **Close** > **Yes** to exit the calibration mode.

4.3.2 1-Point Adjustment with Insight and Reference Transmitter



- Computer with Windows operating system and Vaisala Insight software installed
- Vaisala USB cable 219690 for connecting the probe
- A recently calibrated reference transmitter (for example, another HMD60 transmitter) and the required equipment for powering the reference device and viewing its measurements

This procedure can be used to adjust the humidity (RH) or temperature (T) measurement of the transmitter. If you want to adjust both RH and T (**HMD62**), repeat the procedure for each parameter.



It is assumed that a hole was drilled for the reference instrument during installation, the reference instrument is powered, and you can view the measurement output value.

- ▶ 1. Insert the reference transmitter into the measurement environment next to the transmitter that you are adjusting. The reference transmitter should be inserted approximately 30 cm (12 in) from the HMD60 probe's installation hole, towards the direction of the air flow. See [Figure 9 \(page 14\)](#).
2. Monitor the measurement of the reference instrument and wait until the measurement has stabilized fully.



If you are using a second HMD60 transmitter as the reference device, you can connect both transmitters to Insight simultaneously and view the measurement of the reference device from Insight while making the adjustment.

3. Connect the transmitter you are adjusting to Insight. See [Connecting to Insight Software \(page 27\)](#).
4. Select  **> Calibrate > Yes** to switch the transmitter to calibration mode.
In calibration mode, the transmitter will not use functions that may interfere with calibration and adjustment.
5. Select the type of adjustment to perform: **RH adjustment** or **T adjustment**.
6. Define the needed adjustment for the first measurement point:
 - a. Read the measurement of the reference transmitter (make sure the measurement has stabilized fully).
 - b. Click the **Reference value, point 1** text box and enter the reference value of the calibration point. Press **ENTER** or click outside the text box when done.
 - c. Insight automatically enters the measured values for the calibration point.
7. Select **Activate adjustment > Yes** to store the adjustment in the transmitter.

8. Check the message that appears at the top of the screen. If the message indicates that the adjustment is activated successfully, your adjustment is stored.
9. Select the **Calibration information** tab and update the **Calibration date** and **Calibration text**.
10. Select **Close > Yes** to exit the calibration mode.
11. When done, plug the installation hole of the reference transmitter.

4.4 Calibration and Adjustment with MI70 Hand-Held Indicator

You can use the MI70 hand-held indicator to make a 1-point adjustment to temperature (T) or relative humidity (RH). To connect the transmitter to MI70, you need the optional MI70 connection cable (Vaisala order code 219980SP). For instructions on connecting the transmitter to MI70 and general information about using MI70, see [Overview of MI70 Support \(page 35\)](#).



Before adjusting the measurement with MI70, turn the adjustment trimmer(s) on the transmitter component board back to the ± 0 position. When you adjust the measurement with MI70, the position in which the trimmer is at that moment becomes the new ± 0 point.

More Information

- [Connecting HMD60 to MI70 Indicator \(page 36\)](#)

4.4.1 1-Point Adjustment Using Reference Environment



- A humidity or temperature reference (for example, Vaisala HMK15 Humidity Calibrator) to create the reference condition used in the adjustment.
- MI70 hand-held indicator and MI70 connection cable 219980SP



This example describes an RH adjustment with a humidity calibrator. The same steps can be applied to temperature calibration with a temperature reference.

- ▶ 1. Prepare the humidity reference for the adjustment point you are using (for example, 11 %RH).
2. Connect the transmitter to MI70 indicator with the MI70 connection cable 219980SP.
3. Turn on the MI70 indicator.
4. Insert the probe head into the reference environment.

5. Start the adjustment sequence from **Main menu > Functions > Adjustments**.

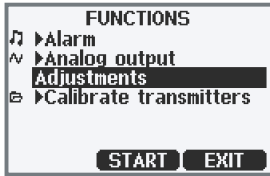

6. MI70 notifies you that automatic power off is disabled during adjustment mode, press **OK** to acknowledge.
7. Select the RH parameter when prompted.



8. The adjustment mode is now active, and you can see the measured RH reading on the screen. To proceed with the adjustment, press **Adjust**.

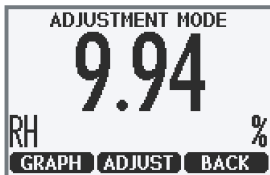

9. Select **1-point adjustment**.
10. You are now in the 1-point adjustment screen. Wait until the measurement has stabilized fully in the reference environment, and then press **Ready**.

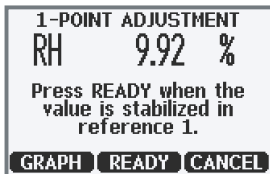

11. Enter the known value of the RH reference with the arrow buttons (for example, 11 %RH) and press **OK**.

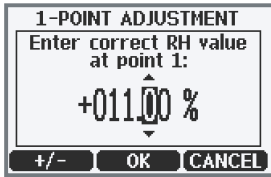

12. You will be prompted if you really want to adjust. Select **Yes**.
13. If the adjustment is successful, MI70 will show the text **Adjustment Done**, after which you will return to the adjustment mode. At this point you can press **Back** and **Exit** to leave the adjustment mode. The adjustment is now completed. If the adjustment cannot be applied, MI70 will show the text **Cannot adjust**, possibly followed by a text stating the reason. A possible reason for an adjustment failure is attempting to apply a very large correction to the reading.

5. Operating with Insight PC Software

5.1 Vaisala Insight Software

Vaisala Insight software is a configuration software for Vaisala Indigo-compatible probes and transmitters. The supported operating systems are Windows 7 (64-bit), Windows 8.1 (64-bit), and Windows 10 (64-bit).



To ensure support for your HMD60 series transmitter, download the latest version of Insight at www.vaisala.com/insight.

With the Insight software, you can:

- See real-time measurements, device information and status.
- Configure outputs and scaling.
- Calibrate and adjust the device.

HMD60 can be connected to Insight using a Vaisala USB cable (order code 219690).

5.2 Connecting to Insight Software



- Computer with Vaisala Insight software installed
- USB connection cable (order code 219690)

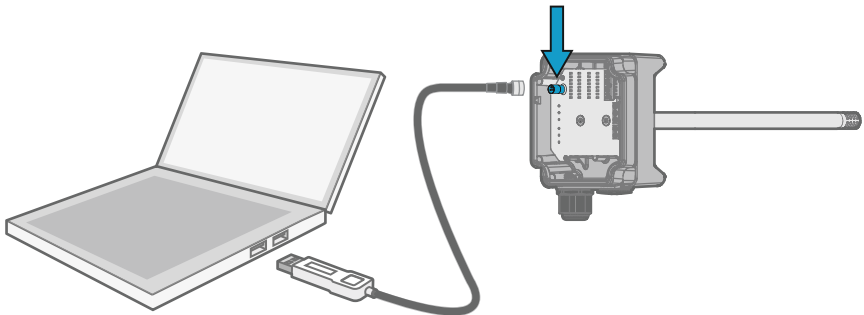

Figure 14 Connecting Transmitter to Insight

- ▶ 1. Open the Insight software.
2. Connect the USB cable to a free USB port on the PC.
3. Connect the USB cable to the service port of the transmitter.

- Wait for Insight software to detect the transmitter.

5.3 Insight Main View

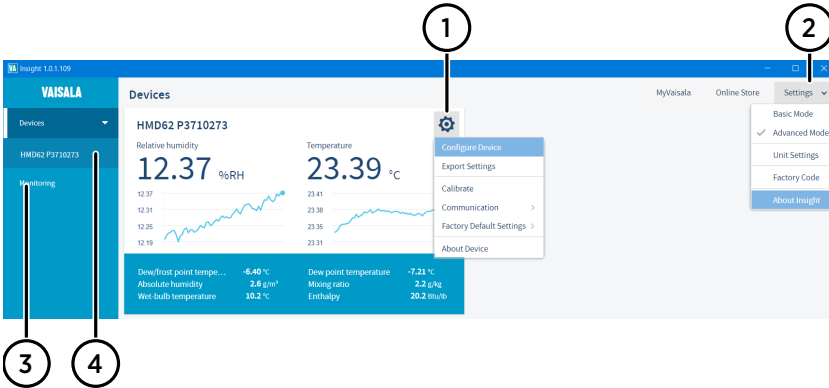



Figure 15 Insight Main Menu and Settings

- Select  to access Insight main menu.
 - Configure Device:** environmental compensation settings, analog output 1 and 2 settings, filtering factor and general settings.
 - Expert Settings:** creates a text file export of the device settings.
 - Calibrate:** options for calibrating and adjusting RH and T output, testing and adjusting current (mA) output levels, and restoring factory adjustments.
 - Communication:** contains a quick access selection for restarting the device.
 - Factory Default Settings:** restores the transmitter back to default settings, clears any user adjustments and restores the latest factory calibration.
 - About Device:** general device information such as serial number and software version.
- Select **Settings** to switch between the **Basic Mode** and **Advanced Mode** user modes, change the units of parameters (metric/non-metric), enter a factory code to access restricted functionalities, or view information about the Insight software.
- Monitoring** provides options for monitoring and recording selected parameters, and exporting the monitoring data as a CSV (comma-separated values) file.
- Device information menu with the following tabs:
 - Measurements:** measurement graph view with parameter drop-down selection.
 - Calibration Information:** read-only information about the latest stored calibration.
 - Diagnostics:** troubleshooting and administrative information about the device status.

5.3.1 Basic and Advanced User Modes

You can switch between the **Basic Mode** and **Advanced Mode** user modes with the selections in the **Settings** menu.

Certain functionalities are only available in **Advanced Mode**. The options enabled by switching to **Advanced Mode** are often intended for administrative users: set the user mode according to the requirements of the personnel that use the device. For example, measurement viewing, calibration and adjustment options, and output scaling are all available also in **Basic Mode**.

5.4 Configuring Analog Outputs with Insight



CAUTION! HMD62 only: Note that the humidity output parameter selected with the DIP switches on the transmitter component board will be used instead of the parameter selected with Insight. When using Insight to configure the output, set all humidity parameter selection DIP switches on the transmitter component board to the **OFF** position (left) to ensure they do not cause a conflict with the Insight settings.



HMD62 only: If you use Insight to set both analog output channels to output T measurement, the humidity parameter DIP switches do not have an effect on the output.

Configure Device

TMD62 P3710282

In Advanced Mode

General

Filtering

Analog output 1

Advanced

Output mode	i	4...20 mA	▼
Output parameter		T	▼
T, scale low end	i	-20.00	°C
T, scale high end	i	80.00	°C
Error output	i	3.6000	mA
Low clipping limit	i	4.0000	mA
Low error limit	i	3.8000	mA
High clipping limit	i	20.0000	mA
High error limit	i	20.5000	mA

Save

Close

Figure 16 Analog Output Configuration Options in Insight (TMD62 Example)

To configure analog output with Insight:

- ▶ 1. **HDM62 only:** Check that the output parameter selection DIP switches on the transmitter component board are switched to the **OFF** position.
2. Connect to Insight and select  > **Configure Device > Analog Output 1[2]**.
3. Select the output mode (either **4 ... 20 mA** or **Off**).
4. Select the output parameter (**TMD62:** only **T** available).



HDM62 only: The default analog output setup for HMD62 is 1 channel for RH and 1 channel for T. Using Insight, you can set any RH and T output combination for the 2 channels (RH+RH, T+T, or RH+T).

5. Enter the lower and upper limits of the output scale for your selected parameter.
6. Set the error output value and the output clipping and error limits.
7. Select **Save** to store the configuration and exit the menu with **Close** when done.

5.4.1 Testing and Adjusting Analog Output Current (mA) Level



- Computer with Windows operating system and Vaisala Insight software installed
- Vaisala USB cable 219690 for connecting the probe to Insight
- Multimeter for checking the analog output reading (connect in series to measure the current output)



Note that configuring these settings requires using Insight in **Advanced Mode**.

You can test the current (mA) output level of the transmitter with a multimeter, and adjust the output level (2-point adjustment) if necessary.

Calibrate Device
 HMD62 P3710273

Calibration information
Factory calibration
RH adjustment
T adjustment
Analog output 1
Analog output 2

Test mode ☐

Test output level

Measured low level

Output low level

Measured high level

Output high level

Activate adjustment

Analog output gain

Analog output offset

Restore factory adjustment

Output Level Adjustment for Analog Output 1 (RH)

In the test mode, you can test the current output level of the transmitter with a multimeter, and adjust the output level (2-point adjustment) if necessary.

Note: Always switch **Test mode** off after testing to return the analog outputs to normal operating mode. Transmitter does not output measurement data when analog outputs are in test mode.

To test and adjust the current output level of the analog output:

1. Switch off the power supply input to the transmitter.
2. Connect a multimeter to the analog output wiring (connect in series to measure the current output).
3. Switch on the power supply input.
4. Enable the **Test mode** (switch to **ON** position).
5. Enter a low output value in mA (for example, **5**) in the **Test output level** field. The transmitter starts to output current at this level.
6. Check the multimeter reading and enter the measured value (for example, **4.95**) in the **Measured low level** field.
7. Enter a high mA value (for example, **19**) in the **Test output level** field, check the multimeter reading, and enter the value of the multimeter reading to the **Measured high level** field.
8. Select **Activate adjustment** to save the correction to the output level.
9. To verify that the current output level of the transmitter is now accurate, enter a new value (for



CAUTION! Always switch **Test mode** off after testing to return the analog outputs to normal operating mode. The transmitter does not output measurement data when the analog outputs are in test mode.

- ▶ 1. Switch to **Advanced Mode** in the **Settings** menu.
2. Select **Calibrate > Yes** to switch the probe to calibration mode.
3. Select the analog output you want to test (**Analog Output 1[2]**).
4. Follow the instructions in the Insight interface to carry out required output tests and adjustments.

5.5 Configuring Minimum and Maximum RH and T Errors with Insight

You can define the minimum and maximum limit that the RH (HMD62 only) or T measurement output can reach before the output moves to error state.



Note that configuring these settings requires using Insight in **Advanced Mode**.

Setting	Value	Unit
Minimum RH error limit	-5.00	%RH
Maximum RH error limit	110.00	%RH
Minimum T error limit	-60.00	°C
Maximum T error limit	100.00	°C

Figure 17 Min/Max Allowed Measurement Value Before Error (HMD62 Example)

To define the minimum/maximum error limits:

- ▶ 1. Switch to **Advanced Mode** in the **Settings** menu.
- 2. Select > **Configure Device** > **Advanced**.
- 3. Enter the values for minimum and maximum RH and T as applicable, select **Save** and exit the menu with **Close**.

More Information

- ▶ [Basic and Advanced User Modes \(page 29\)](#)

5.6 Changing Pressure Compensation Settings with Insight (HMD62)



Figure 18 Pressure Compensation Settings

By default, the pressure value used when calculating HMD62 measurements is 1013.2 hPa.

To change the pressure compensation setting:

- ▶ 1. Select  > **Configure Device**.
2. To change the volatile compensation value (resets back to power-up default at device restart), select **Compensation setpoints**, enter a value, and select **Save**.
3. To change the default compensation value that stays in use also after device restart, select **Compensation power-up defaults**, enter a value, and select **Save**.
4. Select **Close** to exit the menu after you have saved the compensations.

More Information

- ▶ [Environmental Compensation \(HMD62\) \(page 12\)](#)

5.7 Setting Filtering Factor with Insight

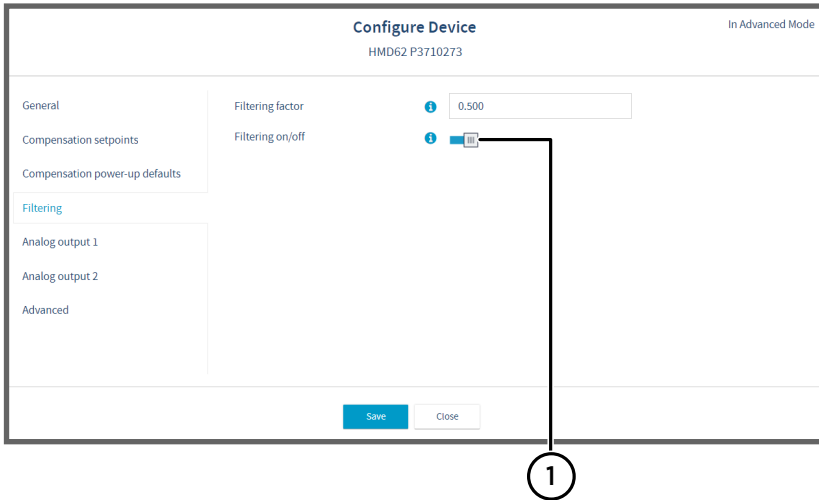

Figure 19 Filtering Factor Configuration View (HMD62 Example)

- 1 Enable filtering by moving the slider to the right (**ON**)

To set a filtering factor for the transmitter's measurement output:

1. Select > **Configure Device** > **Filtering**.
2. Enable filtering with the **ON/OFF** selections (slide right to enable, left to disable).
3. Enter a filtering factor below 1.000 to apply filtering to the output (range: 0.001 ... 1.000).



Examples of the effect of filtering on output:

- Filtering factor 1.000 = No filtering, the latest measurement is output directly without integrating previous measurements.
- Filtering factor 0.500 = The reading output integrates 50% of the previous measurement with the latest measurement.
- Filtering factor 0.100 = The reading output integrates 90% of the previous measurement with the latest measurement.

4. Select **Save** when done and exit with **Close**.

More Information

- [Filtering Factor \(page 12\)](#)

6. Operating with MI70 Indicator

6.1 Overview of MI70 Support

The MI70 hand-held indicator is a convenient service tool for viewing the measurement readings and performing calibration and adjustment. MI70 is used as the display and configuration tool in, for example, the HM70 Hand-Held Humidity and Temperature Meter, and is also compatible with various Vaisala probes and transmitters.

You can use the MI70 indicator for the following tasks with HMD60:

- Measurement viewing and logging
- Calibration and 1-point adjustment (see [Calibration and Adjustment with MI70 Hand-Held Indicator \(page 24\)](#))
- Viewing information about the transmitter (serial number, SW version, last adjustment date)



To connect HMD60 to an MI70 indicator, you need the optional MI70 connection cable (Vaisala order code 219980SP).

6.1.1 MI70 Indicator Parts

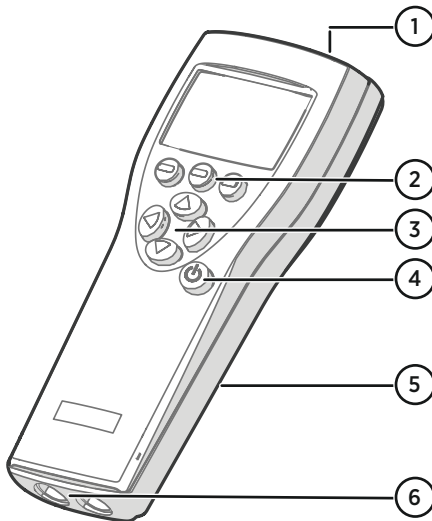







Figure 20 MI70 Indicator Parts

- 1 Charger socket
- 2 Function key shortcut buttons . The functions change according to what you are doing with the indicator.
- 3 Arrow buttons:
 -  Move up in a menu
 -  Move down in a menu
 -  Enter a sub-menu
 -  Return to previous menu level
- 4 Power On/Off button
- 5 Battery compartment at the back of the indicator
- 6 Two ports (labeled I and II) for connecting probes and instruments.

To open menus, press an arrow button and then press the shortcut buttons. To activate a function shown above the shortcut button, press the shortcut button. To navigate in the menus, press arrow buttons.

6.2 Connecting HMD60 to MI70 Indicator



- MI70 connection cable (Vaisala order code 219980SP).
- Medium size crosshead screwdriver for opening the lid screws.

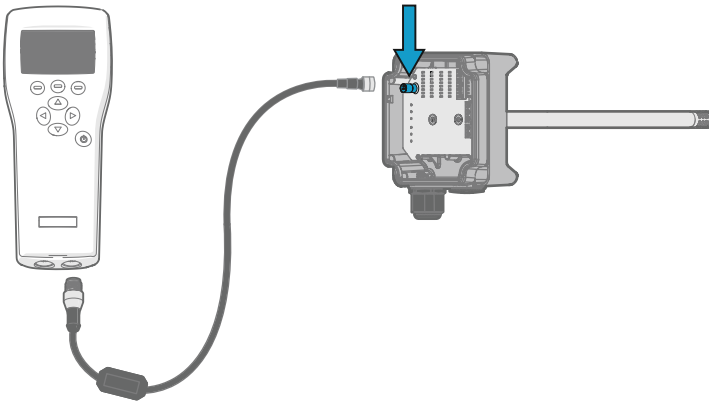

Figure 21 Connecting HMD60 to MI70 Indicator with Cable 219980SP

- ▶ 1. Open the 2 captive screws on the transmitter body and remove the lid.
2. If the MI70 indicator is on, turn it off.
3. Connect the MI70 connection cable 219980SP to HMD60 service port and either of the MI70 connector ports.
4. Turn on the MI70 indicator (time and date are requested at first startup). MI70 detects HMD60 and proceeds to show the measurement screen. MI70 will start to show valid measurement results from HMD60 after a few seconds.

6.3 Basic Display

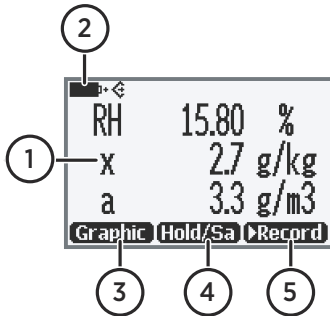

Figure 22 MI70 Basic Display

- 1 Measured parameter and compensations (up to three items on display simultaneously). You can change the shown items in **Main menu > Display > Quantities and units**.
- 2 Battery indicator. Shows current status (charge) of the battery.
- 3 Function key **Graphic** shows the readings as a curve.
- 4 Function key **Hold/Save** freezes the display and you can save the reading in the MI70 memory.
- 5 Function key **Record** is a quick access to the **Recording/Viewing** menu.

You can change the default function key shortcuts (**Graphic**, **Hold/Save**, **Record**) to other menus or functions in **Main menu > Settings > User interface > Program shortcut keys**.

6.4 Graphical Display

The graphical display shows you the measurements as a curve (the curve of the uppermost quantity shown in the basic display). From the curve you can examine the data trend and history of the last minutes.

To open the graphical display, select **Graphic** in the basic display or select **Main menu > Display > Graphic history > Show**.

To get the statistical info on the graph area (minimum, maximum, and average values), press **Info**.

To get the curve of the other selected quantities, press **Next**. To get the curves of all the quantities, press **Next** until the text **All** appears, and then select **All**.

To zoom in and out, press the up/down arrow keys.

To move back and forward in the timeline, use the left/right arrow keys.

6.5 Main Menu

In the main menu, you can configure the MI70 settings and basic display options, view information about the probe, access recordings and clear the memory, set alarms, start adjustments, and use the analog output option of the MI70 indicator.

To open the main menu and navigate in the menus:

- ▶ 1. Go to the basic display.
2. Press any arrow key, then select **Open** (must be pressed within 5 seconds or the indicator returns to the basic display).
3. Move in the menu using the **▲** **▼** buttons.
4. Select an item with the **▶** button.
5. To return to the previous level, press **◀**.
6. To return to normal operation, press **Open** **Exit**.

6.6 Holding and Saving the Display

With the **Hold/Save** function, you can freeze a certain display reading. This reading can be saved in the MI70 memory and it will be available even after MI70 is disconnected from the transmitter.

- ▶ 1. In the basic display, select **Hold/Save**. Alternatively, select **Main menu > Display > Hold/Save display > Hold**.
2. Press **Save**.
3. To view the saved display, go to basic display and select **Record > View recorded data**. Alternatively, select **Main menu > Recording/Viewing > View recorded data**.
A list of saved displays and data recordings appears. The icons on the left of the date and time indicate whether the file is a saved display or a longer recording of data:

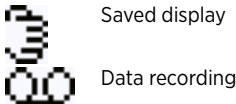

4. Select the saved display based on date and time by pressing the right arrow key.

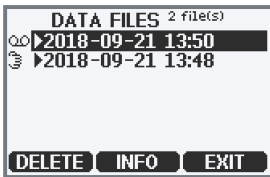

6.7 Recording Data

With MI70, you can record transmitter measurement data over a certain period at chosen intervals. These recordings are saved in MI70 memory and are available even after MI70 is disconnected from the transmitter. To start recording, select the **Record** function key in the basic display, or navigate to the recording menu: **Main menu > Recording/Viewing > Record data**.

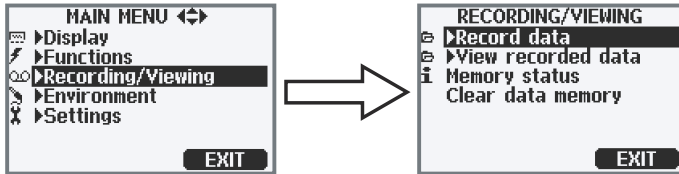

Figure 23 Recording/Viewing Menu

7. Maintenance and Troubleshooting

7.1 Cleaning

You can clean the transmitter and probe body by wiping with a moist cloth. Standard cleaning agents can be used.



CAUTION! Note that the transmitter body is powder coated. Do not use cleaning chemicals that can damage the coating.

When cleaning, follow these precautions:

- Do not immerse the transmitter or probe in liquid to clean it.
- Take care not to damage the PTFE membrane inside the metal grid filter (ASM212652SP) when cleaning. Do not use a pressure washer to clean the filter, and avoid pulling, tearing or puncturing the membrane.
- When changing the filter, you can use clean instrument air to gently blow any loose dirt and filter material from the sensor. Do not attempt to clean the optical surfaces in any other manner.

8. Technical Data

8.1 Specifications

Table 6 Relative Humidity Measurement Performance

Property	Specification
Humidity sensor	Vaisala HUMICAP® R2
Measurement range	0 ... 100 %RH
Stability	±0.5 %RH/year in typical HVAC applications
Accuracy at 0 ... +40 °C (+32 ... +104 °F) (Incl. Non-linearity, Hysteresis, and Repeatability)	
0 ... 90 %RH	±1.5 %RH
90 ... 100 %RH	±2.5 %RH
Accuracy at +40 ... +80 °C (+104 ... +176 °F) and -40 ... 0 °C (-40 ... +32 °F) (Incl. Non-linearity, Hysteresis, and Repeatability)	
0 ... 90 %RH	±2.5 %RH
90 ... 100 %RH	±3.5 %RH
Factory calibration uncertainty	±1.0 %RH
Start-up and Response Time	
Start-up time at +20 °C (+68 °F)	8 s
Response time (T63) at +20 °C (+68 °F)	15 s
Calculated Humidity Parameters (Default Analog Output Scale)	
Dew point	-40 ... +80 °C (-40 ... +176 °F)
Dew point / frost point	-40 ... +80 °C (-40 ... +176 °F)
Absolute humidity	0 ... 300 g/m ³ (0 ... 131.1 gr/ft ³)
Wet bulb temperature	-40 ... +80 °C (-40 ... +176 °F)
Enthalpy	-40 ... 1600 kJ/kg (-9.5 ... 695.6 Btu/lb)
Mixing ratio	0 ... 600 g/kg (0 ... 4200 gr/lb)

Table 7 Temperature Measurement Performance

Property	Specification
Temperature sensor	Pt1000 RTD Class F 0.1 IEC 60751
Measurement range	-40 ... +80 °C (-40 ... +176 °F)

Property	Specification
Default analog output scale	-20 ... +80 °C (-4 ... +176 °F)
Accuracy at +20 °C (+68 °F)	±0.1 °C (0.18 °F)
Temperature dependence	±0.005 °C/°C
Factory calibration uncertainty	±0.1 °C (0.18 °F)
Response time (T63) with free convection	8 min

Table 8 Operating Environment

Property	Specification
Operating temperature, electronics	-40 ... +60 °C (-40 ... +140 °F)
Operating temperature, probe	-40 ... +80 °C (-40 ... +176 °F)
Storage temperature range	-40 ... +80 °C (-40 ... +176 °F)
Maximum flow speed	50 m/s with sintered filter
Electromagnetic compatibility	EN61326-1, Industrial Environment

Table 9 Inputs and Outputs

Property	Specification
Power supply input	10 ... 35 VDC (RL = 0 Ω) 20 ... 35 VDC (RL = 600 Ω)
Analog output	TMD62: 1 × T output 4 ... 20 mA HMD62: 1 × RH output 4 ... 20 mA, 1 × T output 4 ... 20 mA 1
Service port	M8 4-pin male connector: <ul style="list-style-type: none"> • MI70 handheld indicator (requires cable 219980SP) • Vaisala Insight PC software 2 (requires USB cable 219690)
Screw terminal wire size	0.5 ... 2.5 mm ²

- 1) Calculated output parameters for HMD62 and HMD65 include T_{cb} , T_{df} , A , X , T_w , and H .
- 2) Vaisala Insight software for Windows® available at www.vaisala.com/insight.

Table 10 Mechanical Specification

Property	Specification
Housing material	Cast aluminium

Property	Specification
Probe material	Stainless steel
IP rating	IP66 (NEMA 4X)
Weight	511 g (18 oz)

8.2 Spare Parts and Accessories



Information on spare parts, accessories, and calibration products is available online at www.vaisala.com and store.vaisala.com.

Table 11 Spare Parts and Accessories

Spare Part / Accessory	Vaisala Order Code
USB cable for PC operation (Vaisala Insight software)	219690
Connection cable for HM70 (MI70) handheld meter	219980SP
Membrane filter	ASM212652SP
Sintered filter	HM46670SP
Conduit fitting and O-ring (M16×1.5 / NPT1/2")	210675SP
Cable Gland and O-ring (M16×1.5): default option delivered with HMD60	254280SP

8.3 Transmitter Dimensions

The dimensions are given in millimeters and [inches].

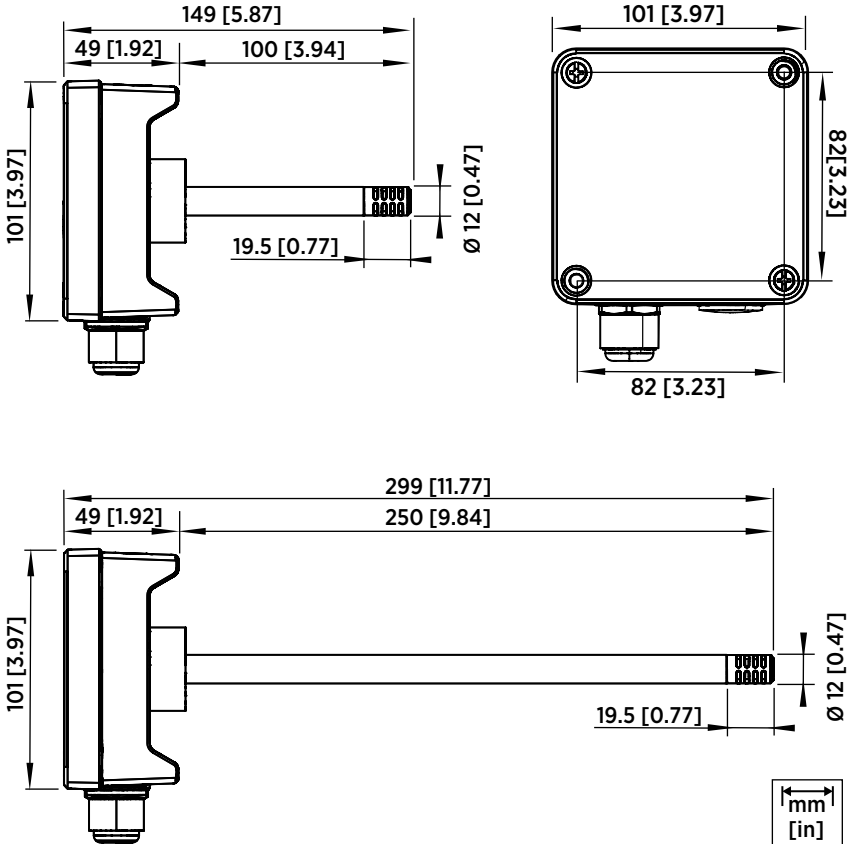

Figure 24 Dimensions with Long and Short Probe

Warranty

For standard warranty terms and conditions, see www.vaisala.com/warranty.

Please observe that any such warranty may not be valid in case of damage due to normal wear and tear, exceptional operating conditions, negligent handling or installation, or unauthorized modifications. Please see the applicable supply contract or Conditions of Sale for details of the warranty for each product.

Technical Support



Contact Vaisala technical support at helpdesk@vaisala.com. Provide at least the following supporting information:

- Product name, model, and serial number
- Name and location of the installation site
- Name and contact information of a technical person who can provide further information on the problem

For more information, see www.vaisala.com/support.

Recycling



Recycle all applicable material.



Follow the statutory regulations for disposing of the product and packaging.

VAISALA

www.vaisala.com

