

Operating Instructions

U10b

Software version 1.03



**Thermal flow sensor
with two parametrisable analog outputs
optional with a display / keypad, M-Bus and WiFi module**

Contents

1	Safety Instructions.....	4
1.1	Specific information.....	4
2	Device.....	5
2.1	Type plate.....	5
2.2	Scope of delivery	5
2.3	Technical specifications.....	5
2.3.1	Operating conditions.....	5
2.3.2	Housing and connection	6
2.3.3	Electrical data.....	6
3	Initial Operation.....	7
3.1	Connections and wiring diagram	7
3.2	Status LEDs.....	8
3.3	Parameter settings	8
4	Display and Operating Module	9
4.1	Start-up.....	9
4.2	Display	9
4.2.1	Error message	10
4.3	Keypad lock.....	11
4.4	Keypad functions	12
4.5	Menu structure	13
4.6	Menu functions	14
4.6.1	Display	14
4.6.1.1	Unit	14
4.6.1.2	Language.....	14
4.6.1.3	Contrast	14
4.6.1.4	Light	14
4.6.2	Interface.....	15
4.6.2.1	M-Bus	15
4.6.2.1.1	Primary address	15
4.6.2.1.2	Baud rate	15
4.6.2.2	WiFi	15
4.6.2.2.1	Switch on/Switch off	15
4.6.3	Info	15
4.6.4	Factory settings	15
4.6.5	Basic settings	16
4.6.5.1	Diameter	16
4.6.5.2	Profile factor	16
4.6.5.3	Absolute pressure	16
4.6.5.4	Damping.....	16
4.6.6	Type of gas	17
4.6.6.1	Medium	17
4.6.7	Characteristics	17
4.6.7.1	Configuration	17
4.6.7.2	Pairs of values.....	17
4.6.8	Standard conditions.....	18
4.6.8.1	Standard temperature	18
4.6.8.2	Standard pressure	18
4.6.8.3	Standard density	18
4.6.9	Analog output 1	18
4.6.9.1	Unit	18
4.6.9.2	Start value.....	18
4.6.9.3	Final value	18
4.6.10	Analog output 2	19
4.6.10.1	Unit	19
4.6.10.2	Start value.....	19
4.6.10.3	Final value	19
4.6.11	Pulse output.....	19
4.6.11.1	Type	19
4.6.11.2	Limit value.....	19

4.6.11.3	Unit	19
4.6.11.4	Factor	19
4.6.12	Quantity counter	20
4.6.12.1	Reset	20
4.6.12.2	Settings.....	20
4.6.12.2.1	Decimal places	20
5	WiFi	21
5.1	Specification.....	21
5.2	Initial operation	21
5.2.1	Initial operation access point	22
5.2.2	Initial operation client mode	22
5.3	Web interface	23
5.3.1	Accessing the web interface.....	23
5.3.1.1	Access point.....	23
5.3.1.2	Client mode without fixed IP address	23
5.3.1.3	Client mode with fixed IP address	23
5.3.2	Operating the web interface	24
5.3.2.1	Info	24
5.3.2.2	Measured value display	24
5.3.2.3	Measured value display (relative time)	24
5.3.2.4	Module settings	24
5.3.2.5	Parameter setting part 1.....	25
5.3.2.6	Parameter setting part 2 (pairs of values).....	25
5.3.2.7	Sprache.....	25
5.3.2.7	This page is used to change the language settings.	25
5.3.2.8	Reset	25
5.3.3	UDP broadcast.....	26
5.3.4	TCP data exchange.....	26
5.3.5	Reset (hardware side).....	27
5.3.7	Switching on the module.....	28
6	Instruction manual for thermal flow sensor category 3G and 3D	29
6.1	Apparatus	29
6.2	Safety Precautions (see chapter 1).....	29
6.3	Technical data	31
6.4	Installation.....	31
6.5	Maintenance.....	31
7	Troubleshooting.....	32
8	Declaration of conformity.....	35



1 Safety Instructions

Danger to life, risk of injury and damage to material or property.

Read the Operating Instructions carefully before initial operation.

Observe general safety precautions as well as those included in various sections of these Operating Instructions.

Hazard risks:

- non-observance of the Operating and Safety Instructions
- modifications to the device by the customer
- handling the device outside the specified operating conditions
- handling the sensors outside the specified operating conditions
- use of unsuitable power supplies and peripheral devices
- improper use of the equipment

Danger when installing the sensors in pressurized pipelines:

- sensors for use in pressurized pipelines are to be inserted or retracted in depressurized conditions only; non-observance may result in serious injuries to personnel
- when installing or removing under pressure, the appropriate protective equipment must be used, e.g. ball valve and probe guide pieces with chain guard or spindle probe guide pieces

The pipes for the measurement gases must be insulated in a way that is ensured that the electronics housing of the apparatus does not assume a higher temperature than the aforementioned maximum ambient temperature. The radiant heat and convection heat has to be considered also.



1.1 Specific information

- pay special attention to the mains voltage when using voltage converters
- when operating outdoors, make sure that the housing cover and the cable gland are screwed tight to the housing, otherwise the degree of protection IP65 is not guaranteed.

2 Device

2.1 Type plate

The following type plate is found on the housing:

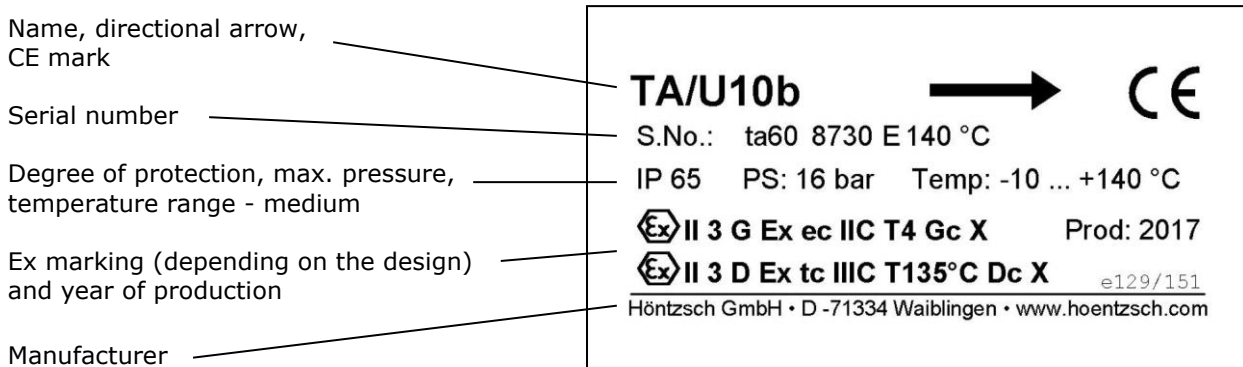

2.2 Scope of delivery

- Flow sensor U10b, optional with display/keypad, M-Bus and WiFi module
- Operating Instructions U10b, Data Sheet TA Sensor

Please check that everything listed in the Delivery Note / Technical Data Sheet is included in the delivery.

2.3 Technical specifications

2.3.1 Operating conditions

Range	: 0.2 ... 200 m/s
Temperature - medium	: -10 ... +140 °C
Ambient temperature	: -25 ... +50 °C : -20 ... +50 °C with optional display
Degree of protection	: IP65, IEC 529 and EN 60 529 with housing cover and cable gland screwed tightly
Pressure resistance	: up to 16 bar / 1.6 MPa overpressure, special design on request
Medium	: pure gas and gas mixtures such as air, nitrogen, methane, propane, butane, natural gas, argon, carbon dioxide, helium, hydrogen, oxygen, landfill gas, ...
Measured variables	: standard flow velocity [Sm/s, Sft/min, Scfm], not possible with M-Bus standard flow rate [Sl/s, Sl/min, Sl/h] or [Sm ³ /s, Sm ³ /min, Sm ³ /h], mass flow m/t [kg/h], standard flow [Sm ³]

2.3.2 Housing and connection

Dimensions	: 80 / 80 / 60 mm (L / W / H) 80 / 80 / 71 mm (L / W / H) with optional display
Housing material	: powder-coated aluminium
Connection	: cable gland M16, for cables with an exterior diameter of 5 ... 9 mm; the cable gland is to be sealed with a torque of 4 Nm. Connection cables for wires with a connection cable 0.2 ... 1.5 mm ² , AWG 24 to 16. Apply wire end sleeves. Bare wires must not be visible after installation. Connection cable temperature range -25 ... +80 °C. Earth terminal for cross-sections of 1.5 ... 6 mm ² . Use a cable lug. The torque for fixture to the earth terminal must amount to 2 ... 3 Nm.
WiFi antenna (optional)	: The WiFi antenna may only be pulled by hand. Do not use any tools for installation.

2.3.3 Electrical data

Power supply	: 24 V DC +/- 10 %
Power consumption	: less than 3 W
Analog output 1 + 2	: 4 ... 20 mA (linear) for flow value and / or temperature, update every 500 ms, burden max. 500 Ohm
Pulse output	: for quantity measurement or as limit value open drain to GND, max. 32 V, 20 mA pulse duration 0.5 seconds, max. pulse frequency 1 Hz per unit of volume internal current limiting, thermal circuit breaker
Bus-system	M-Bus Measured variables in Sl/s, Sl/min, Sl/h, Sm ³ /s, Sm ³ /min, Sm ³ /h and kg/h Quantity counter in Sm ³ Bus-address (0) and baud rate (2400) preset and changeable via M-Bus M-Bus galvanically isolated Bus load: 2 standard-loads (3mA)

3 Initial Operation

For installation and operation of the system, the national regulations currently in force, the recognised standards of good practice and these Operating Instructions apply.

3.1 Connections and wiring diagram

Wiring diagram transducer U10b with 2 analog outputs

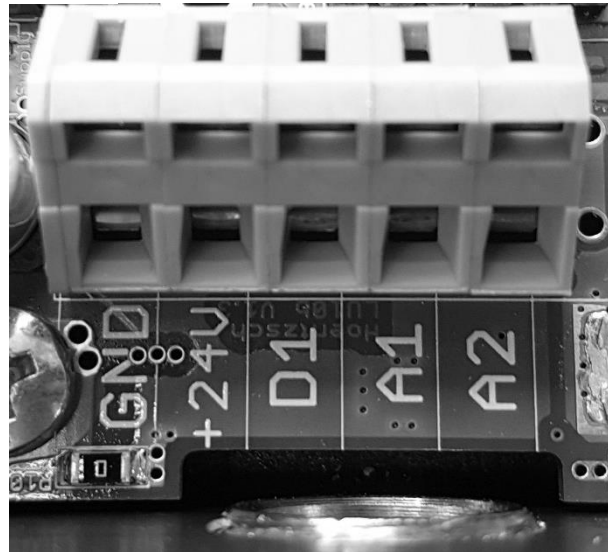
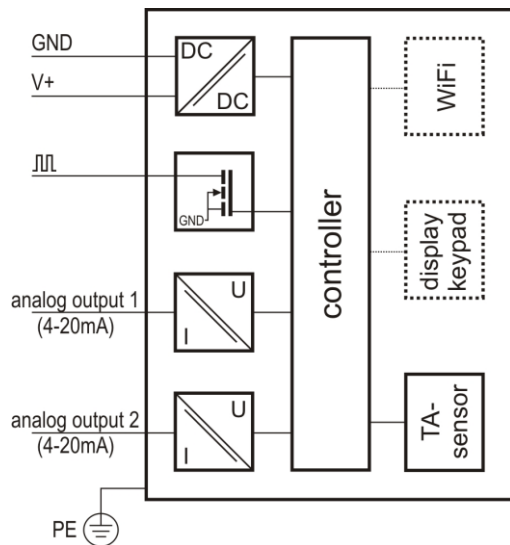

Assignment	Terminal	Explanation
GND	GND	Power supply ground
V+	+24V	Power supply 24 V DC
⏏	D1	Output for pulse or limit value
Analog 1 (4-20mA)	A1	Analog output 4-20 mA, measured variable selectable
Analog 2 (4-20mA)	A2	Analog output 4-20 mA, measured variable selectable
PE	-	Earth terminal on housing

Wiring diagram transducer U10b with 1 analog output and M-Bus option

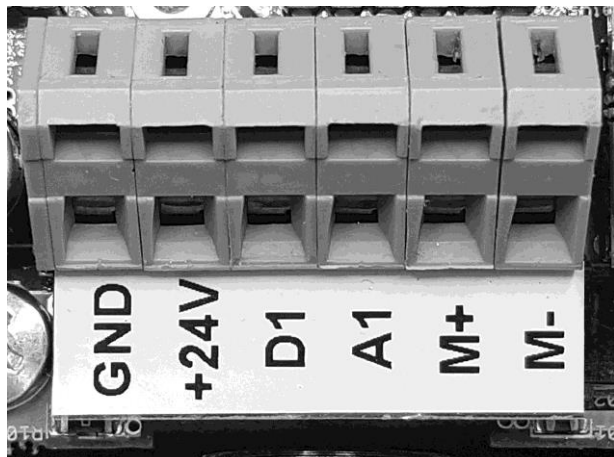
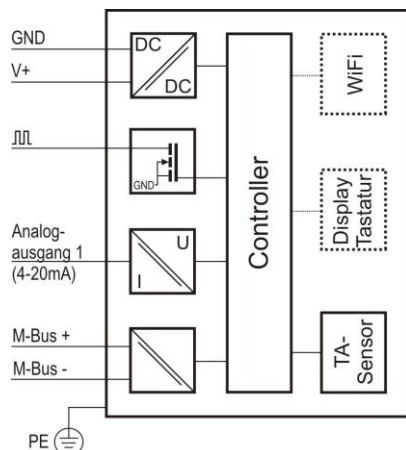

Assignment	Terminal	Explanation
GND	GND	Power supply ground
V+	+24V	Power supply 24 V DC
	D1	Output for pulse or limit value
Analog 1 (4-20mA)	A1	Analog output 4-20mA, measured variable selectable
M-Bus (+)	M+	M-Bus (+), , measured variable selectable
M-Bus (-)	M-	M-Bus (-), , measured variable selectable
PE	-	Earth terminal on housing

3.2 Status LEDs

The device is equipped with two status LEDs which indicate the status of the device independently of the optionally-available display or the WiFi module.

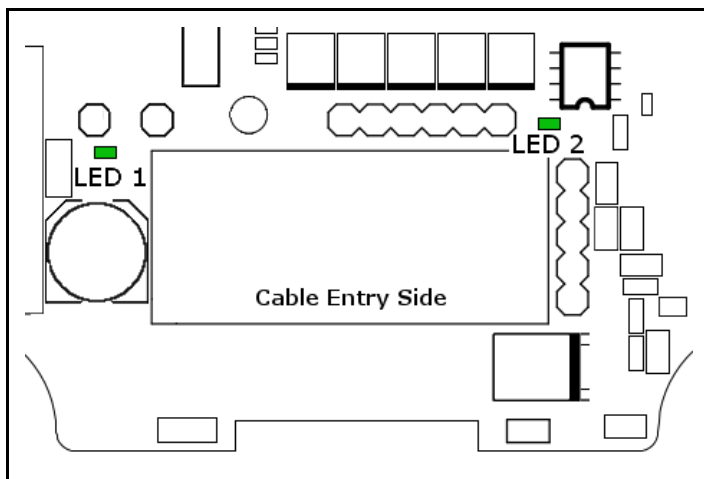

LED 1: Shows the correct polarity of the power supply.

LED 2: This LED illuminates constantly if no flow velocity is measured (0 Sm/s). As soon as the flow velocity is greater than 0 Sm/s, the LED flashes every second. Given an error, the LED flashes every 300 ms or does not light up. Further details regarding troubleshooting are listed in chapter 7.

The description of the LEDs on the WiFi module is to be found in chapter 5.3.6.

3.3 Parameter settings

Parameters can be set via the optional display and operation module (see 4), as well as with the optional WiFi module (see 4.6.2).

Communication parameter: 2400 baud (adjustable) / even parity / 8 data bits / 1 stop-bit / no flow control

The M-Bus-Gateway must be able to allow communication outside the M-Bus protocol. Information regarding the function of your gateway can be received from the respective manufacturer.

4 Display and Operating Module

The functionalities described in this chapter are for units fitted with display and operating module, which are optional.

4.1 Start-up

Following on from the company logo, the name and version of the unit and creation date of the firmware are displayed.

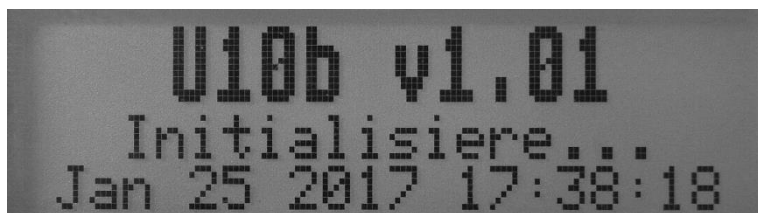

The device is then ready to use and changes to measurement display.

4.2 Display

Various modes are available for displaying the values. These can be enabled in the normal display (menu not open) with the help of the ► - key.

- Two-row text display



Row 1: current measured value – flow rate/mass flow/flow velocity
Row 2: current quantity counter stand

- Three-row text display



Row 1: current measured value – flow rate/mass flow/flow velocity
Row 2: current temperature
Row 3: current quantity counter stand

- Graphical display of flow values



Here the current value is displayed in the heading and the values over the last 10 seconds are displayed graphically. The data runs from right to left with the oldest value on the left edge of the graphic.

- Graphic display of temperature

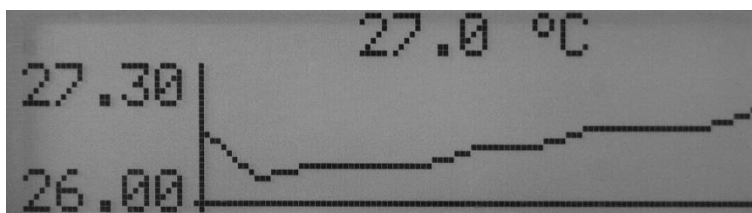

Here the current temperature is displayed in the heading and temperature values measured over the last 10 seconds are displayed graphically. The data runs from right to left with the oldest value on the left edge of the graphic.

- Status

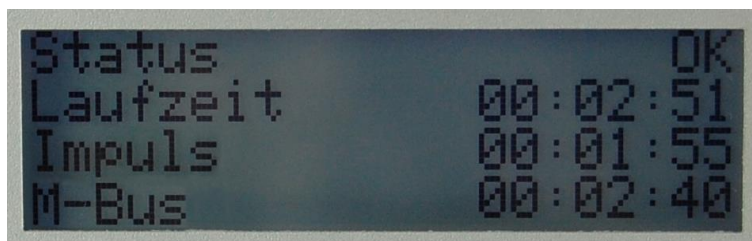

- Row 1: status
- Row 2: uptime (Laufzeit) of the device (in screen: devices is in operation for 0 days, 1 hour, 12 minutes, 53 seconds)
- Row 3: time of the last issued pulse/limit related to the device runtime (in screen: 0 days, 1 hour, 11 minutes, 05 seconds after device start)
- Row 4: time of the last request via M-Bus, related to the device runtime (in screen: 0 days, 0 hour, 2 minutes, 40 seconds after device start)

4.2.1 Error message

Should an error develop, either the corresponding error code (see chapter 7) or a description of the error is displayed. In this case, the error code is available under *Menu -> Device -> Info* as described in chapter 4.6.3.

4.3 Keypad lock

To prevent accidental inputs, the keypad lock can be activated when the menu is shutdown. To do this press the ► and OK keys simultaneously and hold for at least 3 seconds. A message is displayed to acknowledge the keypad lock. Repeat to disable lock mode.

A hardware solution for locking the keypad is also available. With the housing cover open there is an easily accessible board with the jumper "Keypad Lock" for deactivating the keys. When plugged in the keypad can be used, otherwise function is deactivated.

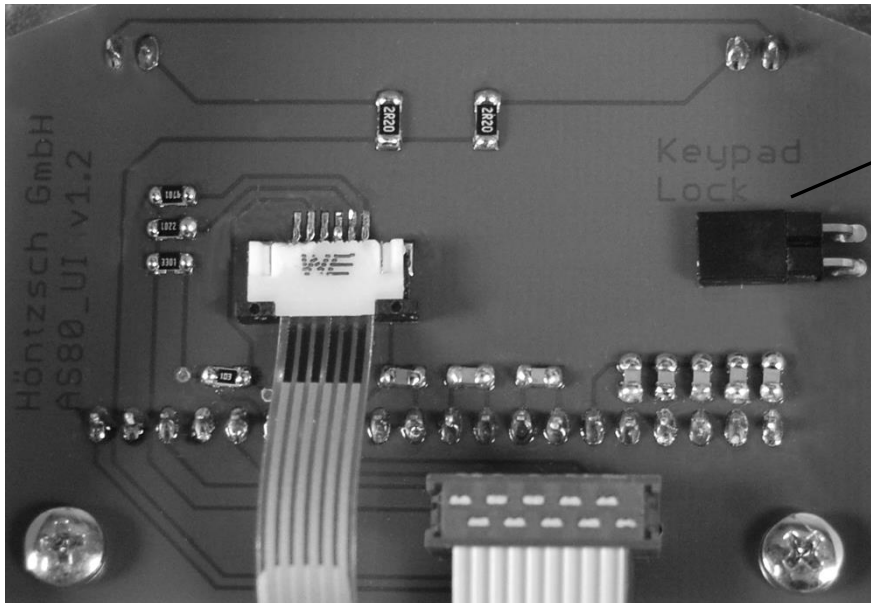

Jumper
for keypad lock

4.4 Keypad functions

OK - key

- open menu
- select menu item
- edit settings
- save changed values
- confirm messages

▶ - key

- change display
- select next menu item
- select next text
- change selection
- change parameter

+ - key

- change parameter

ESC - key

- one menu level up
- reject changes

OK - and ▶ - key

- press for 3 seconds to switch the keypad lock on and off



In the following examples each key function is described in detail:

Examples for the key functions in the menus:

Select list:

With "▶" scroll down

Each chosen element is highlighted

With "ESC" up one level (back)

With "OK" down one level (forward) = select



Parameter value selection:

With the "+" or "▶" key change the selection.

The chosen element flashes (here "Pulse")

With "Ok" save and back to list

With "ESC" back to list without saving

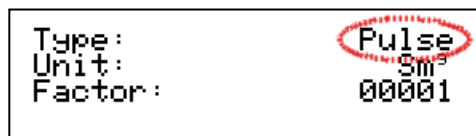

Numeric setting of parameter value or free text field:

With "+" change digit or text

The chosen element flashes (here "1")

With "▶" one digit or text field to the right

With "Ok" save and back to list

With "ESC" back to list without saving

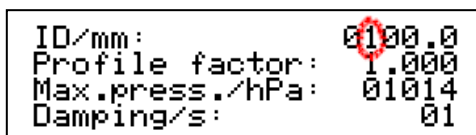

4.5 Menu structure

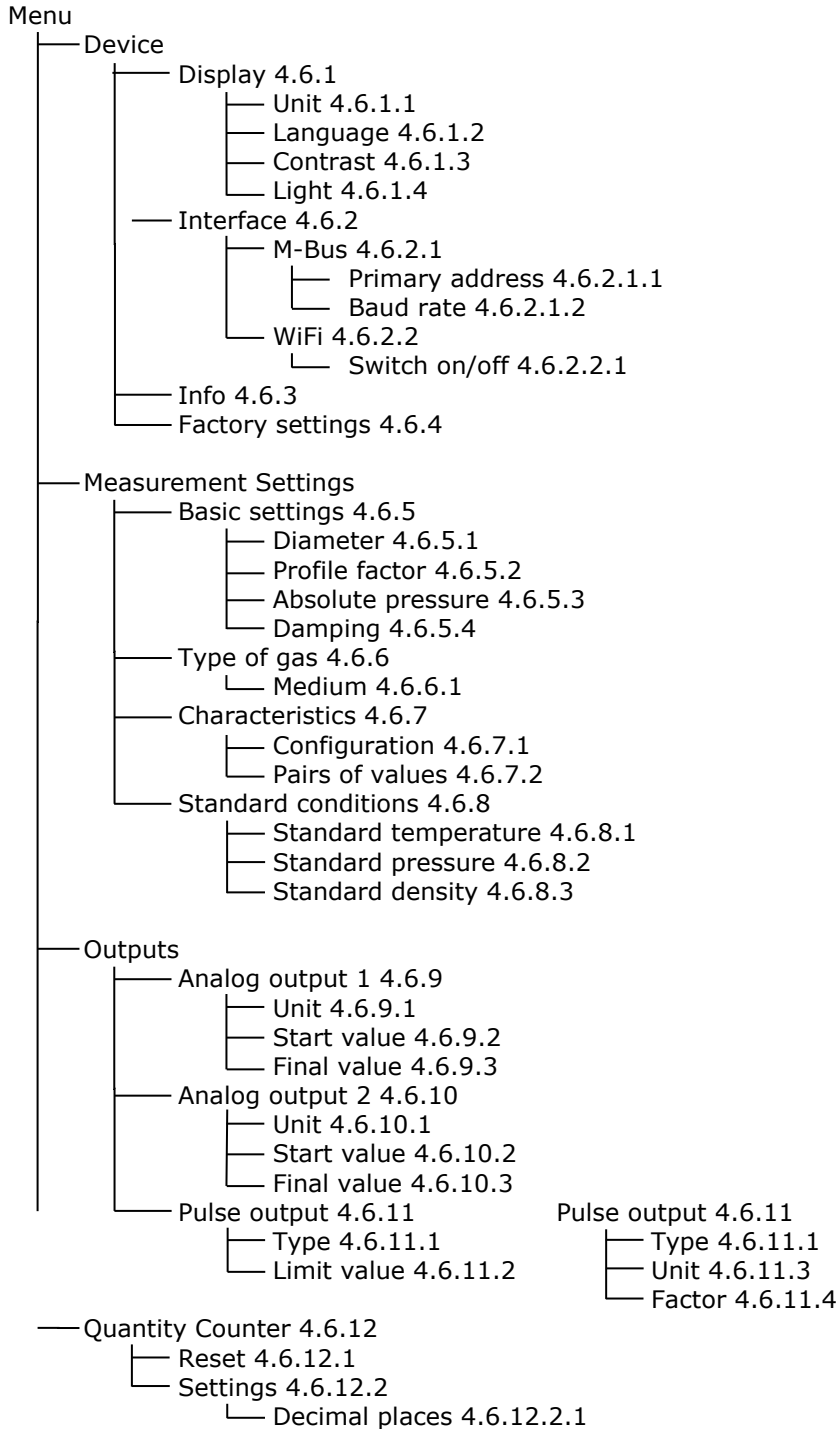

4.6 Menu functions

Settings:

4.6.1 Display

Menu -> Device -> Display

4.6.1.1 Unit

Selection of the unit for LCD and the display via the WiFi module

Selection:	l/s	= Standard flow rate in litre/second calculated from flow velocity, measuring section from input (4.6.5.1) diameter and standard conditions (4.6.8)
	l/min	= Standard flow rate in litre/minute calculated from flow velocity, measuring section from input (4.6.5.1) cross section and standard conditions (4.6.8)
	l/h	= Standard flow rate in litre/hour calculated from flow velocity, measuring section from input (4.6.5.1) cross section and standard conditions (4.6.8)
	Sm³/s	= Standard flow rate in m ³ /second calculated from flow velocity, measuring section from input (4.6.5.1) cross section and standard conditions (4.6.8)
	Sm³/min	= Standard flow rate in m ³ /minute calculated from flow velocity, measuring section from input (4.6.5.1) cross section and standard conditions (4.6.8)
	Sm³/h	= Standard flow rate in m ³ /hour calculated from flow velocity, measuring section from input (4.6.5.1) cross section and standard conditions (4.6.8)
	Scfm	= Standard flow rate in cubic feet/minute calculated from flow velocity, measuring section from input (4.6.5.1) cross section and standard conditions (4.6.8)
	kg/h	= Mass flow rate in kg/hour calculated from flow velocity, measuring section from input (4.6.5.1) cross section and standard conditions (4.6.8)
	Sm/s*	= Flow velocity in standard meters / second
	Sft/min*	= Flow velocity in standard feet / minute

* Setting is not possible with M-Bus

4.6.1.2 Language

Choice of language **German** or **English**

4.6.1.3 Contrast

Adjustable in six stages (0-5)

4.6.1.4 Light

Backlight adjustable in five stages (0 %, 25 %, 50 %, 75 % and 100 %)

4.6.2 Interface

Menu -> Device -> Interface

4.6.2.1 M-Bus

Menu -> Device -> Interface -> M-Bus

4.6.2.1.1 Primary address

Adjustable primary address of the M-Bus in the range of 0 - 250.

The special setting 253 corresponds to a single secondary address; therefore the device does not react to a primary address.

4.6.2.1.2 Baud rate

Selectable baud rate for M-Bus

Selection: **300** Baud
 600 Baud
 1200 Baud
 2400 Baud
 4800 Baud
 9600 Baud
 19200 Baud
 38400 Baud

4.6.2.2 WiFi

Menü -> Device -> Interface -> WiFi

4.6.2.2.1 Switch on/Switch off

Selection: **WiFi:** = **On** or **Off**

Activation or deactivation of the optionally-available WiFi module.

Please note: This menu point is only available with devices equipped with the optional WiFi module

4.6.3 Info

Menu -> Device -> Info

Device information in the form of device designation, serial number, version of the device firmware and the status of the device state.

Following an error, the status of the error code is displayed in accordance with chapter 7.

4.6.4 Factory settings

Menu -> Device -> Factory settings

After separate confirmation, the device is reset to the factory settings. Any changes made after delivery will be lost.

The factory settings are preset to those found in the accompanying documents. Values for customer-specific measuring tasks are taken into account.

The following prompt is displayed before factory settings are restored:

Restore factory settings?

Confirm with "OK" or abort with "ESC".

Settings:

4.6.5 Basic settings

Menu -> Measurement settings -> Basic settings

4.6.5.1 Diameter

ID/mm: Input inside diameter d_i with the unit mm in a range from 0.1 mm – 9999.9 mm.

4.6.5.2 Profile factor

The profile factor PF specifies the ratio of mean flow velocity in the measuring section to flow velocity measured from the sensor. Requirements are centric positioning of the sensor, non-rotational inflow and adequately dimensioned input/output sections (see also Documents U232 and U234).

Set the following profile factors subject to the inside pipe diameter:

Inside pipe diameter d_i in mm	PF for TA10 sensors
25	0.725
27.2	0.740
35.9	0.790
40	0.810
41.8	0.820
50	0.840
> 50	0.840

For measuring in larger free jet as well as larger ducts or measuring tubes, PF = 1.000 results in the local/punctual velocity.



Profile factor for measuring tubes TA Di..., which are calibrated with pairs of values, must always be set at PF = 1.000!

4.6.5.3 Absolute pressure

Max. pressure/hPa: enter working pressure in hPa as absolute pressure for zero correction.

4.6.5.4 Damping

The damping set here has an impact on the measured value display and the value of the analog output.

Damping/s: enter the damping time from 01 to 99 seconds

Example 10 seconds: after every second the arithmetic average of the last 10 seconds is displayed.

4.6.6 Type of gas

Menu -> Measurement settings -> Type of gas

Display and change the media used and the associated value pair characteristics (see chapter 4.6.7).

4.6.6.1 Medium

Here, the operator can choose between various gases, enabling the sensor to be operated with different characteristics.

Selection: **Air**

Nitrogen (N₂)

Argon (Ar)

Methane (CH₄)

Propane (C₃H₈)

Butane (C₄H₁₀)

Carbon dioxide (CO₂)

Landfill gas (approx. 40% CH₄)

Helium (He)

Hydrogen (H₂)

Oxygen (O₂)

Custom 1 = Selection possible only in accordance with customised calibration (see Technical Data Sheet of sensor for details)

Custom 2 = Selection possible only in accordance with customised calibration (see Technical Data Sheet of sensor for details)

4.6.7 Characteristics

Menu -> Measurement settings -> Characteristics

Display and change with the gas characteristics linked to the medium.

4.6.7.1 Configuration

Quantity: enter the quantity of pairs of values (min. 2, max. 30) for processing and display (see chapter 4.6.7.2).

4.6.7.2 Pairs of values

Change the pairs of values characteristics, consisting of multiple pairs of values (to change the number, see chapter 4.6.7.1). A pair of values always consists of a velocity value in m/s and a frequency value in Hz.

Condition: the pairs of values must be ever increasing, i.e. the next velocity and frequency value must always be greater than the previous one.

Example for = 03

01:000.50 m/s, 06000Hz

02:010.00 m/s, 08350Hz

03:040.00 m/s, 12770Hz



If the frequency value is greater than in the last pair of values, then the velocity value is calculated by means of extrapolation. However, this means that the measuring uncertainty increases as this value is then outside the calibrated range.

4.6.8 Standard conditions

Menu -> Measurement settings -> Standard conditions

Standard conditions for Höntzsch are 294.2 K (+21 °C / +70 °F) and 1014 hPa (14.7 psia). Any desired standard basis can be set using the following standard temperature and standard pressure parameters.

4.6.8.1 Standard temperature

S-Temp/K: input in Kelvin

4.6.8.2 Standard pressure

S-Pressure/hPa: input in hPa

4.6.8.3 Standard density

S-Density/kg/m³: input in in kg/m³ to the set standard basis to calculate the mass flow rate.

Outputs:

4.6.9 Analog output 1

Menu -> Outputs -> Analog output 1

Settings for analog output 1 (4 ... 20 mA)

4.6.9.1 Unit

Unit for the start and final value of the analog output

Selection: **SI/s**

SI/min

SI/h

Sm³/s

Sm³/min

Sm³/h

kg/h

Sm/s

Sft/min

Scfm

°C

°F

4.6.9.2 Start value

Start value of the analog output in the selected unit

4.6.9.3 Final value

Final value of the analog output in the selected unit

4.6.10 Analog output 2

Menu -> Outputs -> Analog output 2

Settings for analog output 2 (4 ... 20 mA) (This analog output is dropped with devices with M-Bus option)

4.6.10.1 Unit

Unit for the start and final value of the analog output

Selection: **SI/s**

SI/min

SI/h

Sm³/s

Sm³/min

Sm³/h

kg/h

Sm/s

Sft/min

Scfm

°C

°F

4.6.10.2 Start value

Start value of the analog output in the selected unit

4.6.10.3 Final value

Final value of the analog output in the selected unit

4.6.11 Pulse output

Menu -> Outputs -> Pulse output

Settings for pulse output

4.6.11.1 Type

Switching between limit value and pulse

Selection: **Limit value**

Pulse

4.6.11.2 Limit value

If "limit value" was chosen as type of pulse output, then the limit value in Sm/s can be specified here. (average flow velocity)

4.6.11.3 Unit

If "pulse" was chosen as type of pulse output, then the unit for the pulse output can be defined here.

4.6.11.4 Factor

If "pulse" was chosen as type of pulse output, then the factor for the pulse output can be set here.

Example - unit Sm³ and factor 100: the pulse output sends one pulse per 100 Sm³.

4.6.12 Quantity counter

Menu -> Quantity counter

Settings for the quantity counter

4.6.12.1 Reset

Resets counter to 0 after prompt.

4.6.12.2 Settings

Counter settings.

4.6.12.2.1 Decimal places

Determines the number of decimal places in the display in the range of 0-3.

5 WiFi

The functionalities described in this chapter are for units fitted with a WiFi module, which is optional. When working via WiFi, you can use any internet-capable device to access the measuring device, control and transfer measurement data and change the device configuration.

5.1 Specification

Antenna: 2.15 dBi. Only replace an antenna with that of an identical type. Ensure a min 20 cm clearance between all persons and the antenna during operation.

Standard: IEEE 802.11b/g/n
Frequency: 2.4 GHz (2412~2472 MHz).

5.2 Initial operation

The WiFi module is to be setup directly after the device has been connected, as security demands that the pre-set password be changed soon.

During device initial operation, the device generates a self-sufficient wireless network with a SSID in the following form:

SSID	hoentzsch U10b XXXXX CONFIG
------	-----------------------------

XXXXX is replaced by the serial number of the respective device.

Open the settings for the wireless network on your PC, Mac, smart phone, tablet or another internet-capable device and connect with the hotspot.

The pre-set password of the configuration access point is "U10b_SNRxxxxx" where xxxxx corresponds to the 5-digit serial number.

Once the connection has been established, start your browser and enter "u10b.com" or "192.168.0.1" in the browser address bar to reach the device configuration page. First select one of the available languages. You then come to the WiFi module configuration.

Device setup

Login	<input type="text" value="Admin"/>
Password	<input type="password" value="....."/>
Parameters password protected	<input checked="" type="checkbox"/>
Enable client mode	<input type="checkbox"/>
Enable access point	<input checked="" type="checkbox"/>
Access point password	<input type="password" value="....."/>
use custom/fixed IP	<input type="checkbox"/>
TCP/UDP port	<input type="text" value="502"/>

The following section explains the individual points:

Login and password:

Overwrite the login and the appendant password. This protects functions such as the alteration of device parameters and the resetting to factory settings against unauthorised access.

Password-protected parameters:

Here you can choose whether changing the flow sensor parameters should be password-protected.

Enable client mode:

Choose this option if the device is to be incorporated in an existing wireless network. If this option has been selected, chapters 5.2.1 and 5.3.1.1 are irrelevant.

Enable access point:

Choose this option if the device is to generate a local hotspot.

If this option has been selected, chapters 5.2.2, 5.3.1.2 and 5.3.1.3 are irrelevant.

Access point PW:

Password protecting the access point, info access point and the configuration access point. Security demands that the password be changed during initial operations.

Use custom/fixed IP:

Select this option if you wish to award a fixed IP address. When working in client mode, ensure that the selected IP matched the existing network and has not yet been issued.

Otherwise, when in client mode, the device will be assigned an IP address by the DHCP server of the existing network. The assigned IP address can be taken from a special info access point at a later point.

You can also obtain the IP address via the router/DHCP server. In this case, the info access point is of no use.

Working in client mode, we recommend assigning the device a fixed IP address, so that the device can always be reached via the same IP address; thus for example, it is not necessary to dial in with a different IP address after loss of network (DHCP server dependent). The client mode without fixed IP is used to determine a valid IP address in the existing network. It is then possible to configure with a fixed IP with the IP address thus determined.

When "Activate access point" has been selected, you can use this option to assign the device with an address which deviates from "192.168.0.1".

TCP/UDP port:

Port selection for data exchange via TCP or UDP. See chapter 5.3.3 and 5.3.4.

Save settings:

If you do not wish to accept the changes, load the page using the browser. Otherwise, click on "save settings".

5.2.1 Initial operation access point

With "Activate access point" selected, the saving of the settings leads to the display of a button for activation. Clicking on this button stops the configuration access point and the current access point / local hotspot is started.

5.2.2 Initial operation client mode

After selecting "Enable client mode" a key will appear after saving: this leads the user to the WiFi settings. Clicking on this button makes the device search for existing wireless networks. Renewed loading of the page enables this process to be repeated.

Select the desired wireless network / add a new network manually. After clicking on the "connect" button, the configuration access point will be held and the device will attempt to connect with the selected network. If this is not possible, the configuration access point will be restarted. A new connection attempt can be started with the reset button. If you have e.g. entered the incorrect password, you will need to repeat the previous steps.

5.3 Web interface

5.3.1 Accessing the web interface

5.3.1.1 Access point

The device generates a self-sufficient wireless network with a SSID of the following form:

SSID	hoentzsch U10b XXXXX
------	----------------------

XXXXX is replaced by the serial number of the respective device.

Open the settings for the wireless network on your PC, Mac, smart phone, tablet or another internet-capable device and connect with the hotspot. The password is that issued in the configuration access point. Once the connection has been established, start your browser and enter "u10b.com" or the IP address of the device in the browser address bar. The IP address is either the fixed address which you determined or the standard IP address "192.168.0.1". Successful entry results in the display of the web interface.

5.3.1.2 Client mode without fixed IP address

If the device has succeeded in connecting with the wireless network which you selected, it will generate an additional info access point with an SSID in the following form:

SSID	hoentzsch U10b XXXXX
------	----------------------

XXXXX is replaced by the serial number of the respective device.

If you are unable to ascertain the assigned IP address in a different fashion, open the settings for the wireless network on your internet-capable device and connect with this hotspot. The password is that issued in the configuration access point. Once the connection has been established, start your browser and enter "u10b.com" or the IP address "192.168.0.1". After successful entry, a screen is displayed containing the name of the wireless network connected with the device and the IP address. Copy or note the specified IP address. The info access point can also be deactivated at a later point; we recommend that you keep this active for the present.

Connect with the specified wireless network. Enter the IP address which you noted previously in your browser; the device web interface will be loaded.

The Info access point must not be ended. You can end it at any time via the separate Info access point or the web interface which has just opened. For this, consult chapter 5.3.2.4 sub-heading "Deactivating the info access point".

If you know the IP address assigned to the device, connect with the wireless network which you have selected from chapter 5.2.2. Enter the IP address in your browser; the device web interface will be loaded. In this case, the info access point is of no use and can be closed at any time. This is performed either via the access point or the web interface as described in chapter 5.3.2.4.

5.3.1.3 Client mode with fixed IP address

If the device has succeeded in connecting with the wireless network, open the wireless network settings on your PC, Mac, smartphone, tablet or other internet-capable device and connect with the wireless network selected in chapter 5.2.2.

Enter the fixed IP address in your browser; the device web interface will be loaded.

5.3.2 Operating the web interface

The following screen shows the device home page. The following section explains the individual links. Usable browsers are Mozilla Firefox, Google Chrome, Opera and Safari.

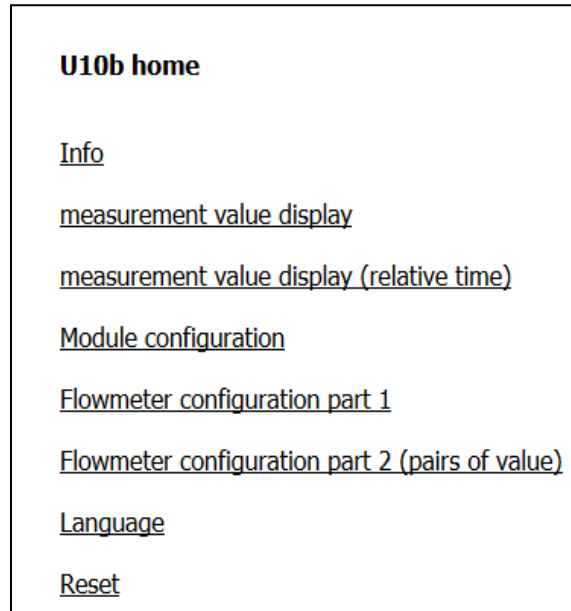

5.3.2.1 Info

Page with device information e.g. runtime, device status etc.

5.3.2.2 Measured value display

Visualisation of the measured values using three independently operable graphs. A graph displays the current volume flow, the mass flow or the current flow velocity. The second graph shows the temperature and the last graph shows the quantity counter. You can zoom within the individual graphs. Use the mouse to "click & drag" on a touch screen by pulling two fingers apart. Double-click on the respective graph to return to the standard view. The screen also provides a measurement data export in CSV format.

5.3.2.3 Measured value display (relative time)

This type of measured value display is performed similarly to 5.3.2.2, but the measured values on the time axis are not labelled with the time, but are numbered sequentially. The screen also provides a measurement data export in CSV format.

5.3.2.4 Module settings

This page is used to change the WiFi module settings. The selectable options are explained here:

The screenshot shows the "Device configuration" page with the following settings:

Refresh rate	<input type="text" value="500"/>	ms
Number of data points in graph	<input type="text" value="100"/>	
Enable UDP broadcast	<input type="checkbox"/>	
Enable data exchange via TCP	<input checked="" type="checkbox"/>	
Disable info access point	<input type="checkbox"/>	

Refresh rate:

Setting the interval of the measured value update in the graphs of the measured value display. Values over 500 ms averages the measured values accordingly and can deviate from the values in the optional display.

Number of data points in graph:

The graphs of the measured value display start with the data recording when accessing the page. This option enables definition of the number of measured values in the graphs. When this limit has been reached, the old values are removed from the graph when new values are added. Too many data points can slow the browser speed.

Enable UDP broadcast:

To activate / deactivate the UDP broadcast. For further information regarding UDP broadcast, see chapter 5.3.3

Enable data exchange via TCP:

To activate / deactivate the TCP data exchange. For further information regarding TCP data exchange, see chapter 5.3.4

Disable info access point:

To deactivate the info access point. This option is only visible with an active info access point and can only be used for final deactivation.

5.3.2.5 Parameter setting part 1

This page is used to parametrise the device. The structure and function are similar to the display menu. For details regarding the individual parameters, see chapter 4.5 to [4.6.8](#)

5.3.2.6 Parameter setting part 2 (pairs of values)

This page is used to enter the pairs of values of the gas currently set. For details see chapter 4.6.7.2

5.3.2.7 Sprache

This page is used to change the language settings.

5.3.2.8 Reset

The reset functions are password-protected. Enter the login selected during initial operation and the appendant password (see chapter 5.2).

Reset the quantity counter:

Resets the flow sensor quantity counter to zero.

Reset flow sensor to factory settings:

Resets the flow sensor to factory settings .

Reset WiFi module:

Resets the WiFi module. All network settings will be lost and the WiFi module must be setup again as described in chapter 5.2.

Reset all:

Resets the flow sensor to the factory settings and deletes the network settings of the WiFi module. The WiFi module must be setup again as described in chapter 5.2.

Please note: When accessing the information page, making changes to the WiFi module configuration or the flow sensor parameters and resetting all end the transmission of the current measurement data. This means that the measured value display, TCP data exchange and UDP broadcast are restricted at this point / are not available and may need to be restarted.

5.3.3 UDP broadcast

If UDP broadcast is activated (see chapter 5.3.2.4, "Activating the UDP broadcast" for activation) the device sends the measurement data to the IP in the form XXX.XXX.XXX.255 and the set port. As a result, you can receive from every device in the same IP range.

The measurement data have JSON (JavaScript Object Notation) format.

Example data set: {"temp": "20.0", "flow": "0.00", "vol": "11"}

"temp" is the current temperature of the medium in Nm³.

"flow" is the current value of the flow unit set.

"vol" is the current value of the quantity counter in Nm³.

5.3.4 TCP data exchange

Communication with U10b measuring transducer via TCP/IP. The IP address and port number of the measuring transducer are required. These are variable and depend on the selected settings.

The U10b measuring transducer with integrated WiFi module answers the TCP package addressed to it. The data field must contain a valid 16 bit (2 byte) ID. Every ID stands for a function.

TCP package to the measuring transducer:

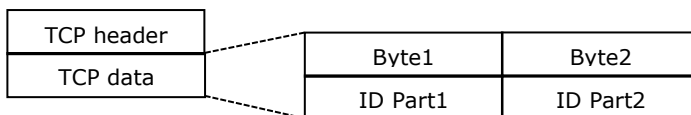

TCP package from the measuring transducer (answer):

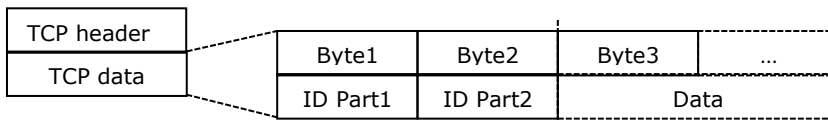

The response of the measuring transducer always contains the ID on which the device answers within the first 2 bytes. Depending on the ID, the response data sent from byte 3 has a varying length and different data type.

The following table lists the IDs used:

ID	Data type (from byte 3)	Size of data field* (Byte)	Description
0x0000	ASCII	Variable	Device name
0x0001	ASCII	Variable	Serial number
0x3000	Float	4	Current flow velocity
0x3010	ASCII	Variable	Current flow velocity as string
0x3020	ASCII	Variable	Flow velocity value unit
0x4000	Float	4	Current temperature
0x4010	ASCII	Variable	Current temperature as string
0x4020	ASCII	Variable	Temperature unit
0x5000	Double	8	Current quantity counter stand
0x5010	ASCII	Variable	Current quantity counter value as string
0x5020	ASCII	Variable	Quantity counter unit
0x5000	Byte 3 to 6: Float Byte 7 to 10: Float From byte 10: Double	4 + 4 + 8 = 16	Complete data set; Byte 3 to 6: Current temperature Byte 7 to 10: Current flow value From byte 10: Current quantity counter stand

* The first two bytes of the message ID are not evaluated with this size indication.

5.3.5 Reset (hardware side)

The WiFi module password can be reset should it become lost. To do so, work with caution to open the housing cover (comply with the regulations for the ex area). Press the setup key for six seconds to reset (see image).

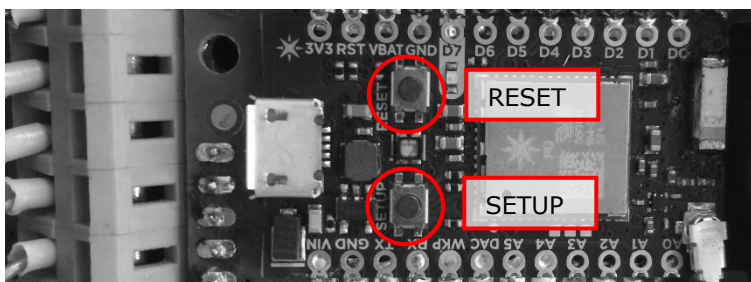

Then you can setup the device afresh as described in chapter 5.2.

The reset key has no influence on the settings performed and can e.g. be used to perform a restart or a repeated dialling attempt into an existing wireless network.

5.3.6 Status display

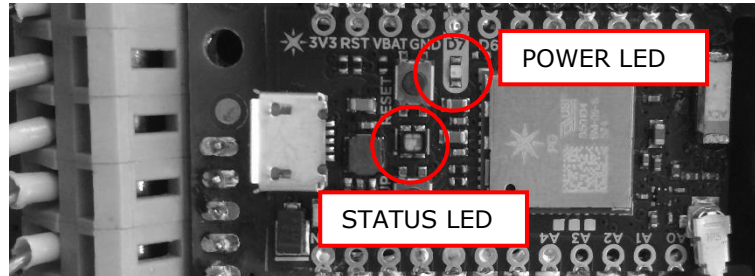

The two LEDs on the WiFi module and displayed in the picture above have the following meaning:

Power LED:

Signals that the module is supplied with voltage.

Status LED:

Off: The module has been switched off / an error has developed. Start the module again (chapter 5.3.7) or perform a reset (chapter 5.3.5).

Illuminates white: Programme start

Illuminates red / purple: Initialisation and network start / establishment.

Flashes Blue: Active configuration access point – develops if the device has not been set up or was unable to log in to the specified wireless network.

Flashing green: normal operation.

Green constantly illuminated: Error, reset required.

Flashing red: Connection with the wireless network lost (automatic re-connection is performed if possible).

5.3.7 Switching on the module

If the device is equipped with a display with keypad, you can switch the WiFi module on and off. See chapter 4.6.2.1. This function can be used to restart the WiFi module.

6 Instruction manual for thermal flow sensor category 3G and 3D



Failure to comply with the specifications of the operating manual can result in an explosion.

6.1 Apparatus

Thermal flow sensors TA 10 and measuring tubes TA Di with integrated or separate evaluation unit

Intended use

The equipment listed as suitable for use in a potentially explosive atmosphere (3G and 3D) are sensors for the measuring of flow velocity, volume flow and temperature of gases. They are designed for use in area in which category 3G or category 3D apparatus is required.

When the equipment is operated normally within the limits of the technical specifications, excess temperatures, electric arcs and sparks are not probable.

Intrinsic heating does not need to be taken into account for category 3G; the maximum permissible additional surface temperature for 3D is 135 °C. Maximum media temperature: see type plate and the appendant technical documents.

The U10b evaluation electronics with the appendant sensors may not be used

- In areas in which category 1G or category 2G equipment is required
- In areas in which category 1D or category 2D equipment is required.



6.2 Safety Precautions (see chapter 1)

6.2.1 General

Hazard risks:

- modifications to the device by the customer
- handling the device outside the specified operating conditions
- handling the sensors outside the specified operating conditions
- improper use of the equipment

Danger when installing the sensors in pressurized pipelines:

- sensors for use in pressurized pipelines are to be inserted or retracted only in depressurized conditions; non-observance may result in serious harm to personnel
- when installing or removing under pressure, the appropriate protective equipment must be used, e.g. ball valve and probe guide pieces with chain guard or spindle probe guide pieces

The pipes for the measurement gases must be insulated in a way that is ensured that the electronics housing of the apparatus does not assume a higher temperature than the aforementioned maximum ambient temperature. The radiant heat and convection heat has to be considered also.

6.2.2 Use in potentially explosive atmospheres

Danger when use of the device in potentially explosive atmospheres:

- The flow sensors may only be used in areas specified for category 3G (zone 2) or category 3D (zone 22) apparatus.
- If severe variations in temperature are to be expected, the device should be left to adapt to the ambient temperature for at least one hour before use to avoid problems with condensation.
- The housing cover may only be opened and connection cables may only be connected or disconnected after the supply voltage has been disconnected.
- Instrument sensors with a separate evaluation unit may only be connected or disconnected when voltage-free. Protect the connection cables against opening.
- Before starting measurement in an explosive atmosphere, check whether the housing cover has been screwed down correctly.
- Mechanical shocks are to be avoided.
- Damaged instruments must not be used. This also applies to damage on the housing.
- Connection cables must be performed in AWG24 or stronger.
- The connection cable used must be approved for the temperature range of the evaluation electronics as a minimum.
- Any covering of dust on the electronic housing may not exceed 5 mm.
- Only the manufacturer's cable glands ducts included in the scope of delivery or permitted, identical cable glands may be used.
- For devices with M-Bus option, make sure that the bus lines are limited to a maximum voltage of 44 V against ground and equipotential bonding system.

Category 3G and category 3D apparatus listed in chapter 6.1 is to be used solely in areas in which the ambient temperature range **for the electronic housing** does not exceed -25 to +50 °C. The display and keypad are not permitted in category 3G or category 3D explosive areas.

Category 3G and category 3D apparatus listed in chapter 6.1 is to be used solely in areas with the temperatures marked on the type plate for the measuring medium and ambient atmosphere and for the maximum permissible overpressure. The additional maximum surface temperature in the category 3D areas amounts to 135 °C. Maximum media temperature: see type plate and the appendant technical documents.

6.3 Technical data

Marking: **CE**  **II 3 G**

Explosion protection: Thermal sensors TA
Ex ec IIC T4 Gc X (option display and keypad not possible)

Marking: **CE**  **II 3 D**

Explosion protection: Thermal sensors TA
Ex tc IIIC T135 °C Dc X (option display and keypad not possible)

X: There are certain special factors to be observed for applications in potentially explosive atmospheres (see 6.2.2)

6.3.1 Electrical data

For power supply, power input, current consumption, refer to the details on the type plate and corresponding technical documents; see chapter 2.3.3.



6.4 Installation

The current European Specifications for Assembly, the recognised standards of good practice and this Instruction Manual apply.

We recommend a cable with a 1.5 ... 6 mm² cross section for connection to the earth terminal. Use a cable lug.

The earth terminal must be tightened with a torque of 2 ... 3 Nm.

Use connection cables which have been cleared for a temperature range of -25 ... +80 °C.



6.5 Maintenance

Maintenance work on the equipment is to be carried out solely by Höntzsch GmbH & Co. KG.

7 Troubleshooting

Fault	Cause	Troubleshooting
Device not working	Insufficient power supply	Check power supply and cable socket
	Faulty electronics	Return to factory
Display is blank	Insufficient power supply	Check power supply and cable socket
	Initialisation or update failed	Depress the ESC and OK keys simultaneously for two seconds to reinitialise the display.
	Broken connection	Disconnect the device, open the housing cover and check that the cable between motherboard and display is fitted correctly
	Faulty electronics or display	Return to factory
No values	Sensor contaminated	Clean the sensor in accordance with the cleaning instructions
	Incorrect measurement settings	Compare and correct according to specifications in the Technical Data Sheet
Faulty value on analog output	Incorrect settings for the analog output	Check all the settings in accordance with chapter 4 or 5 (optional display or WiFi module is required)
	Fault mode	If LED 2 flashes (see chapter 3.2) every ca. 300 ms, the device has detected a malfunction. Check the power supply and restart the device / should the analog output remain faulty, remedy the error notified via the optional display or WiFi module in accordance with the error code table listed (see below).
Value too low	Sensor contaminated	Clean the sensor in accordance with the cleaning instructions
	Incorrect measurement settings	Compare and correct according to specifications in the Technical Data Sheet
	Profile factor set too low	Set the profile factor to a value belonging to a specified range and sensor type, see also 4.6.5.2
	Input/output section too short	Change sensor position; improve flow conditions with a flow straightener
	Rotational flow	Reposition sensor in flow direction; use flow straightener
Value too high	Incorrect measurement settings	Compare and correct according to specifications in the Technical Data Sheet
	Profile factor set too high	Set profile factor to a value affiliated with the nominal diameter and sensor type; see also 4.6.5.2
	EMC problem	See reference to electromagnetic compatibility (EMC) in sensor documents

Fault	Cause	Troubleshooting
No M-Bus communication	Incorrect baud rate setting	The baud rate of the device must be set according to the used baud rate. See chapter 4.6.2.1.2
	Incorrect primary address	Check primary address of the devices in the bus. Set address of the device to an available address. See chapter 4.6.2.1.1
	Incorrect set of primary and secondary address	Check used primary and secondary address in the installed evaluation unit (software, data logger, e.g.)
No WiFi communication	Incorrect wireless network or incorrect IP address	Working in client mode, determine the IP address of the device and enter it in the browser address bar. When using access point mode, connect with the wireless network of the device, enter the password selected upon initial operation and enter "u10b.com" in the browser address bar. If you have forgotten the login data or are unable to determine the IP address, reset the WiFi module (see chapter 5.3.5) and reset the wireless network.
	Missing data in the flow diagrams	If the measurement value graph can be accessed on the web interface, but no measurement points appear on the screen even despite repeated re-loading of the page, contact your system administrator when using client mode. The measurement data sent from the device to the browser will probably be blocked.
	No connection possible	Check the WiFi module status display (see chapter 5.3.6). If it is impossible to establish a connection despite the module having been setup correctly and the LED flashes green (no error or configuration mode) restart the WiFi module using the display and the keypad or the reset key. Should you still be unable to establish a connection, reset the WiFi module (see chapter 5.3.5) and reset the wireless connection.
	WiFi module without function	Check the WiFi module status display. If a LED does not light up, check the status LEDs (chapter 5.3.6) and the device power supply. If a correct function is not possible, contact the Höntzsch service department.
	No TCP/IP communication with the module possible	TCP mode inactive or the port used is blocked by a firewall. Activate data exchange via TCP (see 5.3.2.4) and ensure that the port set has been given clearance.
	EMC problem	See reference to electromagnetic compatibility (EMC) in sensor documents
Keypad not working	Keypad deactivated via jumper or the keypad lock on the display	Insert the jumper in the housing cover and deactivate the key lock on the display (see chapters 4.3 and 4.4)
Error message in display	Device has encountered an error when setting up or in operation	Troubleshooting as in the list of error codes below

In the initialisation phase and during operation the device status is monitored and in case of failure provides relevant feedback. The device status display will show the error code, the notification and the description of the error (see chapter 4.2.1) or under *Menu -> Device -> Info* (see chapter 4.6.3). An explanation of the error codes is listed below.

Error code	Cause	Troubleshooting
001 - 100	Initialisation failed	Reboot the device. If the error message is still displayed, then a hardware fault is probably the reason
301 302	Sensor value outside of defined range	Clean the sensor in accordance with the cleaning instructions
303	TA settings outside of defined range	Compare and correct according to specifications in the Technical Data Sheet, if necessary, restore factory default settings (see 4.6.4)
304 - 309	Error in TA sensor	Clean the sensor in accordance with the cleaning instructions. If the error message is still displayed after cleaning and rebooting, then a hardware fault is probably the reason
400	No pair of values linearization available – check pairs of values	Compare and correct according to specifications in the Technical Data Sheet
401	Value outside of calibration / value too high	Check the flow velocity and compare with the calibration values of the sensor
501	Error in the settings of analog output 1	Check the start and final value of analog output 1.
502	Error in the settings of analog output 2	Check the start and final value of analog output 2.
503	Error in the device settings	Check the medium set and the stored calibration characteristics.
510	Undervoltage detected	Check power supply and cable socket

If one of the listed errors occurs and neither troubleshooting nor rebooting is able to rectify it, then restore the default settings (see 4.6.4). Should the error persist, please contact Höntzsch GmbH & Co. KG using the contact details on the last page of this Operating Instructions.

8 Declaration of conformity

We, Höntzsch GmbH & Co. KG
Gottlieb-Daimler-Str. 37
D-71334 Waiblingen

bearing sole responsibility, hereby declare that the product

U10b

Thermal flow sensor with two
parametrisable analog outputs and
an optional display/keypad, M-Bus and WiFi module

to which this declaration refers conforms with the following standards or standard documents:

Provisions of the Directive	Reference no. and date of issue
2014/34/EU: Devices and protective systems for intended use in potentially explosive areas	EN 60079-0:2012+A11:2013 EN 60079-7:2015
2014/30/EU: Electromagnetic Compatibility	EN 61000-4-2 EN 61000-4-3 EN 61000-4-4 EN 61000-4-5 EN 61000-4-6 EN 61000-4-16 EN 61000-4-29 EN 55011 Rad. EN 55011 Cond.
2014/53/EU: Radio Equipment Directive	EN 301489-1 EN 301489-17 EN 300328 EN 62311:2008
2011/65/EU: Hazardous Substances in Electrical and Electronic Equipment	
M-Bus	EN 13757-2 EN 13757-3



Waiblingen, 12.09.2019

Jürgen Lempp / Managing Director

Höntzsch GmbH & Co. KG

Gottlieb-Daimler-Straße 37

D-71334 Waiblingen

Tel: +49 7151 / 17 16-0

E-Mail info@hoentzsch.com

Internet www.hoentzsch.com

Subject to alteration