

User's Information VA Probes

Supplementary to this User's Information we refer to the corresponding **Technical Data Sheet** with the specific data relating to your order and details of the Manual as well as to Data Sheets **Vortex Flow Sensors VA** and **Flow Velocity Calibration VA**. The data in these documents supplements the following User's Information.

Warning

- Probe in pressurized pipeline:
 - insertion or retraction of probe in depressurized conditions only!
 - In the case of probe guide pieces with probe attachment by TEFLON® clamping bush: increase the tension on the clamping bush from time to time (TEFLON runs causing the clamping fixture to lose initial gripping power)
- Probe with probe guide piece: after positioning a probe in the pipeline fix the probe tube!

Flow direction

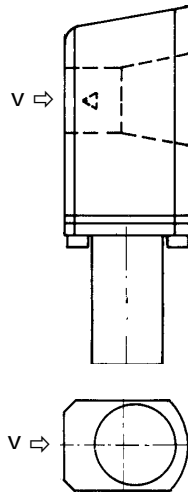

Probe alignment

Vortex flow sensors VA are to be aligned in the direction of flow.

Installation deviating from the nominal position

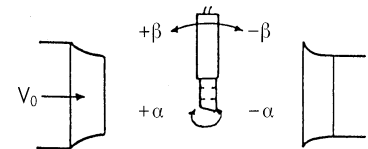
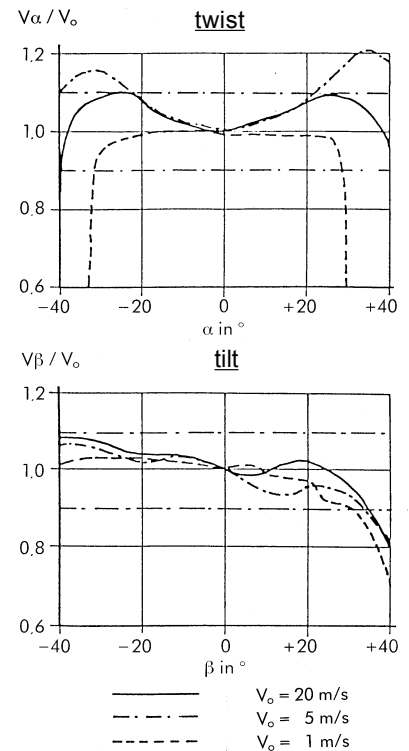

Fitting instructions

The probes should be so fitted that

- flow is according to the flow direction provided for.

Alignment estimated by sight does not interfere with the measurement. Rather more deviations from the nominal position can however affect the measurement; see illustration.

In the case of probes with connection housing the flow direction arrow on the connection housing is to be aligned to the direction of flow. In the case of probes without connection housing an adjustable 'direction indicator' can be used to determine the sensor flow direction and insertion depth.

- the probe mounting device does not affect the flow if possible.
- they are fitted vibration-free and not in the immediate vicinity of electromagnetic sources of interference.
- when using several probes together, two probes should not be placed in too short a distance from each other. A space of 1 m in the direction of flow is always "good"; however, the space between two probes on the measuring plane may be 10 cm. At lesser distances it should be checked for safety that the output values at zero flow are actually zero.
- no drops hit the sensor. When condensation arises on the sensor a horizontal positioning of the sensor is to be favoured.

In the case of wet gases the use of the module **VSM wet gases** can be necessary. The module VSM allows for a considerably improved vortex flow sensor signal recognition even in partially wet gases.

The limits between 100% saturated flow of gas, occasional condensation attack on the sensor, or severe or slight continual condensation attack are flowing. In the case of continual and severe condensation attack, faulty measurements may arise for the duration of this condition, even when using the VSM. The application limit of our vortex flow sensor has been reached at this point. We recommend that the VSM only be used in severe condensation attack if the

Input/output sections

When measuring in a measurement section of inside diameter D_i it must be observed that optimal accuracy when converting the local velocity v_p to the average velocity v_m

$$v_m = v_p \cdot PF$$

(PF, CF = Profile Factor, Coefficient) is only guaranteed when input/output sided irrotational flow prevails and moreover sufficient straight, unhindered input section as well as sufficient straight, unhindered output section is available.

The illustrations show the recommended minimum pipe length, given as a multiple of D_i . The use of greater lengths is always advisable.

Should a suitably long, straight section line not be available then the measurement cross section is to be so placed that 2/3 of the straight pipe section are upstream and 1/3 downstream of the measurement cross section.

Standard designs of flow straighteners, see for example DIN ISO 5167-1 'Measurement of fluid flow by means of pressure differential devices'

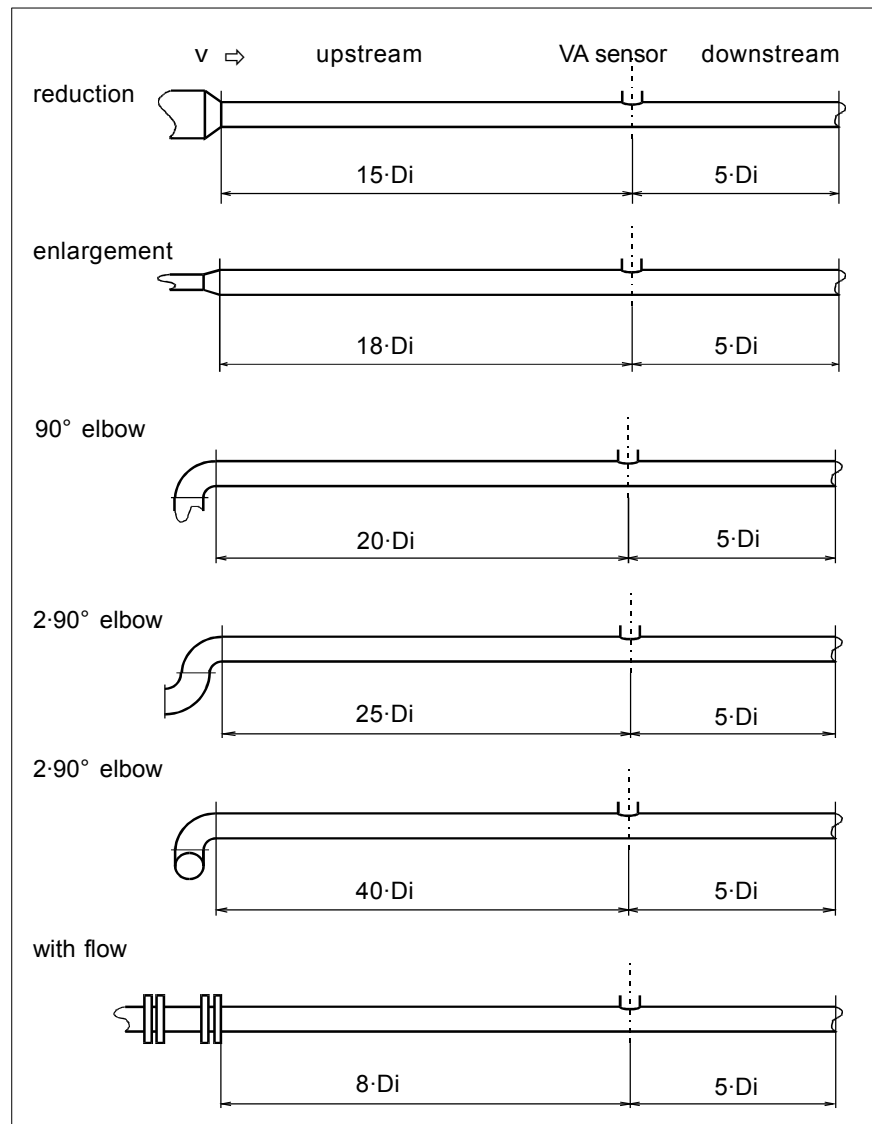

Greater measurement cross sections

To determine the average flow velocity v_m in greater measurement cross sections a preliminary examination is to be carried out to determine the flow profile/ measurement cross section topography. As a result of this study an optimum measuring point is to be fixed and the associated coefficient for the conversion of the local velocity v_p to the average velocity v_m to be stipulated.

For further information see for example

- VDI/VDE 2640-3 'Measurement of gas flow... Velocity area method'
- Result report of the Hessian State Institute for the Environment, 'Environmental Planning, Protection of Labour and Environmental Protection Pamphlet 167': Überprüfung der Repräsentativität von Meßpunkten bei der Ermittlung der Emissionen luftfremder Stoffe unter Anwendung von Meßquerschnitts-topographien, MQT-Verfahren.
- Data Sheet VA, 'Coefficient / Profile factor'

Calibration number KKZ

The calibration number KKZ describes the course of a calibration curve. It is the basis for the linearization of a VA sensor characteristic. The KKZ is individually determined for each sensor and must be deposited at the appropriate evaluation unit:

- in the case of an evaluation unit with keypad and display: check the effective parameter settings by using the \rightarrow key (inquiry mode) and if necessary enter KKZ appertaining to the sensor via the keypad.
- in the case of a transducer without keypad and display please make sure that the sensor fabrication number shown on the transducer is the same as the fabrication number of the connected sensor.

Circuit diagram

VA sensor with evaluation unit only to be connected according to appropriate circuit diagram.

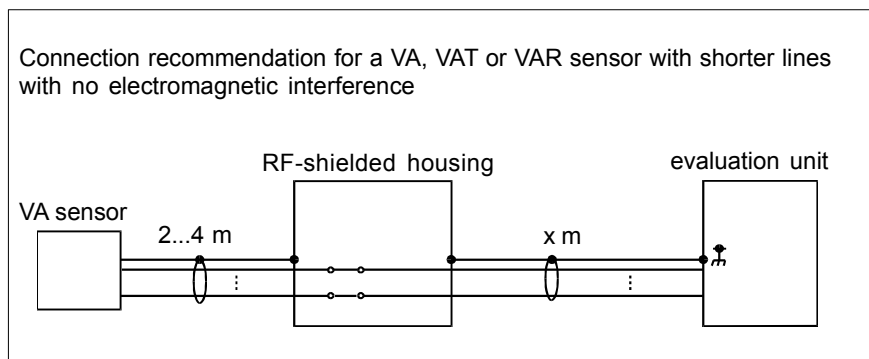
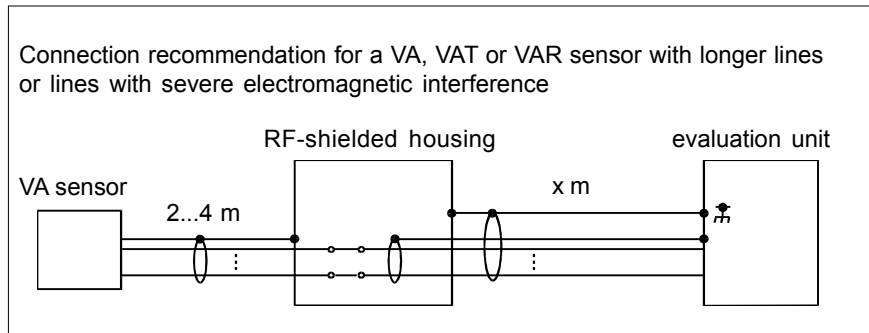

Connection line

For the connection between sensor and evaluation unit - in the case of shorter lines with no electromagnetic interference - a line with simple copper shielded braid can be used: LiYCY. In the case of longer lines or lines with severe electromagnetic interference a double-shielded line only is to be used: LiYCY-CY. Number of wires and cross section in mm² for each wire: for VA sensors 3·0.25, VAT sensors 7·0.25, VAR sensors 4·0.25. Maximum conductor resistance for each wire: 15 Ω. Resistances for fine-strand wires according to VDE 0295 / IEC 228:

79 Ω/km	with wire cross section 0.25 mm ² ,
39 Ω/km	with wire cross section 0.50 mm ² ,
26 Ω/km	with wire cross section 0.75 mm ²

EMC information

for installation in facilities with interference emitting components:

- In the case of lines over 30 m or lines with severe electromagnetic interference - lines between sensor and evaluation unit - the use of a

- double-shielded line is recommended: lay inner shield on one side of the evaluation unit, lay outer shield on both sides covering a large area and of low impedance at sensor and evaluation unit.
- Special separation of lines emitting interference from measuring cables and evaluation units.
- When using frequency converters the influence of RF interference emittance must be taken into consideration from the outset and increased active and passive anti-interference measures must be taken: Decouple the mains input of the frequency converter by means of a spark filter against active interference emittances. In addition this increases the passive resistance to jamming of the facility.
- Special attention should be directed to the motor wire. The motor wire between converter and motor should be shielded, the shielding being on both sides.
- Metallic parts in the service cabinet - as for instance sub-rack with control electronics or mounting plates - very good large area and RF-like conductive connection.

- Relays, contactors, electro valves installed in the same circuit to be wired by means of spark arrester combinations or excess-voltage limiting components.
- Lay the shielding from analog signal lines only on one side - if possible at the evaluation unit - and of low impedance. Twist non-shielded lines: is effective against balanced interference to source terminals.
- Lay shieldings from digital signal lines on both sides over a large area. In the case of potential differences between these points: lay separate potential equalization lines.
- For connections on connection cable points of separation use preferred shielded plug connector. When using terminals: place terminals in an RF-shielded housing and use EMC-correct cable leads. Contact outer shielding of the connecting line to the cable leads.
- All lines to be kept short! Loops in the line can destroy protective measures. Lay non-reserved wires in a cable on both sides on earthed wire potential. Lay cables and wires close to the reference potential, for instance side panels, mounting plates or steel girders.

Causes of trouble

no measured value:

- coefficient set at 0.000
- sensor not connected (display EEEE or FFFF)
- parting of connection cable or short in the connection cable (display EEEE or FFFF)

measured value too low:

- coefficient set too low
- coefficient too low for the measuring position. See 'Greater Measurement Cross Sections': Flow profile other than expected, e.g. caused by subsequent structural alterations to the measurement section. Please note: the flow profile can change dependent on velocity when the input/output sections are too short.
volumetric display: pipe inside diameter Di setting too small
- rotational flow with centric positioning of the sensor
- sensor not optimally aligned to the flow or at twisted positioning of 180°
- reduced acoustic coupling in the sensor element as a result of strong vibration or impact (for instance sensor has been dropped).
- effective electromagnetic interferences
burden at current output greater than permissible according to Technical Data Sheet. Effect: correct output values in a lower part of the measuring range, no longer increasing output values in an upper part of the measuring range.
- setting of the scaling for the analog output not as expected
wrong calibration number KKZ

Measured value fluctuates:

- time constant set at too low
- value
expected measured value fluctuation does not correspond to the
- actual measured value fluctuation
effective electromagnetic interferences

Measured value too high:

- coefficient set too high
- coefficient too high for the measuring position. See 'Greater Measurement Cross Sections': Flow profile other than expected, e.g. caused by subsequent structural alterations to the measurement section. Please note: the flow profile can change dependent on velocity when the input/output sections are too short.
- volumetric display: pipe inside diameter Di setting too great
- effective electromagnetic interferences
- wrong calibration number KKZ

other causes of trouble

- all parameters altered: effective electromagnetic interferences. Unlike incorrect parameter settings by the user, electromagnetic interference usually results in parameter settings which cannot be effected by operating error. In the case of an evaluation unit with keypad and display: use the → key for parameter inquiry. This inquiry mode does not change the
- settings.
expected measured value fluctuation does not correspond to the actual measured value fluctuation: time constant set too high

Maintenance

In applications where dirt can settle on the sensor, sensor should be cleaned at regular intervals!

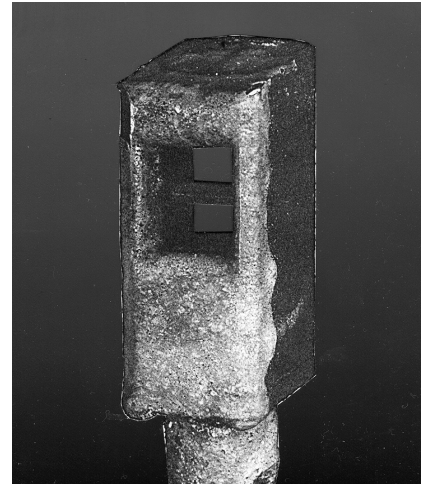

Cleaning the sensor

Vortex flow sensors should be cleaned at regular intervals when being used where dirt can be deposited on the sensor. Start by checking the necessity for cleaning at short intervals by visible inspection in order to establish an optimal cleaning interval.

Soiled measuring probes can be cleaned with a paint brush or small rag using a cleaning agent which does not leave residue when dry. Just dampen rag or brush. When choosing the cleaning agent pay attention to the compatibility with the sensor materials. Hardened deposits can be removed with a metal brush.

Corrective maintenance

to be carried out by Höntzsch GmbH. Please enclose a description of errors when returning faulty instruments. If the instruments have been used in hazardous materials please inform us of any safety precautions to be taken during corrective maintenance. We see it as a conscientious duty to our staff to request you to furnish us with this information.

Service

Please contact Höntzsch GmbH

Höntzsch GmbH

P.O. Box 1324 D-71303 Waiblingen
Gottlieb-Daimler-Straße 37
D-71334 Waiblingen (Hegnach)
Telephone 07151/1716-0
Facsimile 07151/58402

